

Intelligent Pump Controller

Installation & Operation Manual

M931

Ver.1.1



Conventions used in this manual

In the manual the following symbols will be used:



Generic danger Failure to comply with the safety regulations that follow can irreparably damage the controller or equipment.



Electric shock risk Failure to comply with the safety regulations that follow can cause death or serious personal injury.

WARNINGS

Read this manual carefully before any operation.
Please keep this manual for future use.



WARNING!!

- Before carrying out any installation or maintenance operation, controller must be disconnected from the power supply;
- Don't open the cover during running the controller;
- Don't put wire ,metal bar filaments etc into the controller;
- Don't splash water or other liquid over the controller;



CAUTION

- The electrical and hydraulic connections must be carried out by competent, skilled.qualified personnel;
- Never connect AC power to output uvw terminals;
- Ensure the motor, controller and power specifications matching;
- Don't install the controller in the following condition;

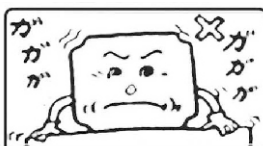

mechanical shock



corrosive gas or
corrosive liquid

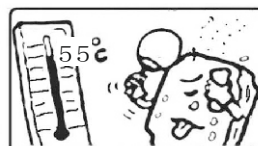

Extreme heat and cold,
acceptable temperature
range: -25°C +55°C

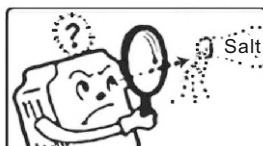

Salt mist corrosion



Rain and Moisture



flammable material:
solvent

TABLE OF CONTENTS

1 INTRODUCTION1.
1.1 Applications1.
1.2 Technical parameter & features1.
1.3 Controller components.....	.3.
2 INSTALLATION5.
2.1 Electrical connection to the power supply line and electrical pump5.
2.2 Function switch setting.....	.6.
2.3 Connections for pump over temperature protection(where supplied with pump).7.
2.4 Parameter Calibration setting & erasing8.
3 ELECTRICAL CONNECTION9.
3.1 Installing liquid probe & float switch9.
3.2 Electrical connection for different application10.
3.2.1 Water supply by liquid level control through float switch or liquid probe10.
3.2.2 Water supply by pressure control through pressure switch & pressure tank15.
3.2.3 Drainage by liquid level control through float switch & liquid probe19.
3.2.4 Drainage by level transmitter22.
3.2.5 Water supply by pressure control through pressure transmitter24.
3.2.6 Water supply by level transmitter26.
4 BASIC OPERATION28.
4.1 Switching to MANULA mode.....	.28.
4.2 Switching to AUTO mode28.
4.3 Pump protection.....	.28.
4.4 Pump last five failure record displaying.....	.28.
4.5 Pump accumulative running time displaying.....	.29.
5 TROUBLE SHOOTING GUIDE30.

RESPONSIBILITY

The manufacturer is not liable for malfunctioning if the product has not correctly been installed, damaged, modified, and /or run outside the recommended work range or run outside the recommended work range or in contrast with other indications given in this manual.

The manufacturer declines all responsibility for possible errors in this operation manual, if due to misprints or errors in copying.

The manufacturer reserves the right to make any modifications to products that it may consider necessary or useful, without affecting the essential characteristics.

1 INTRODUCTION

Thank you for choosing our products, we will supply you with cordial and well-around service as well as ever.

Intelligent Pump Controller is an easy to use, programmable controlling & protection device for direct start, three phase deep well submersible pump, centrifugal pump, pipeline pump etc with output power from 0.75KW to 15KW (1HP-20HP)

The product has many operation modes by adopting different electric installations. An important feature that makes the difference between The product and common On/Off pump control box is the probe / sensor free in the well. Our special design makes it a very reliable and sensitive protection against pump dry run without installation probe / sensor in the well.

1.1 Applications

The product is useful in all cases we need to control and protect single pump managing its turn-on and turn off by different electric installations.

Typical usage scenarios include:

- Houses
- Flats
- Holidays houses
- Farms
- Water supply from wells
- Irrigations of greenhouses, gardens, agriculture
- Rain water reuse
- Industrial plants
- Waste water tank / Sewage sink

1.2 Technical parameter & features

Main features:

- Built In function switch
 - applied for water supply by liquid level control through float switch or liquid probe
 - applied for water supply by pressure control through pressure switch and pressure tank
 - applied for drainage by liquid level control through float switch or liquid probe
- Automatic stops the pump in the case of water shortage, protecting it from dry running without installing float switch or liquid probe in the well
- Auto / Manual switch
- Dynamic LCD displaying pump running state
- Protect the pump against many faults
- Push Button Calibration
- Pump Accumulative Running Time Displaying
- Pump Last Five Fault Record Displaying
- Starts and stops the pump in accordance with the different liquid level or pressure setting





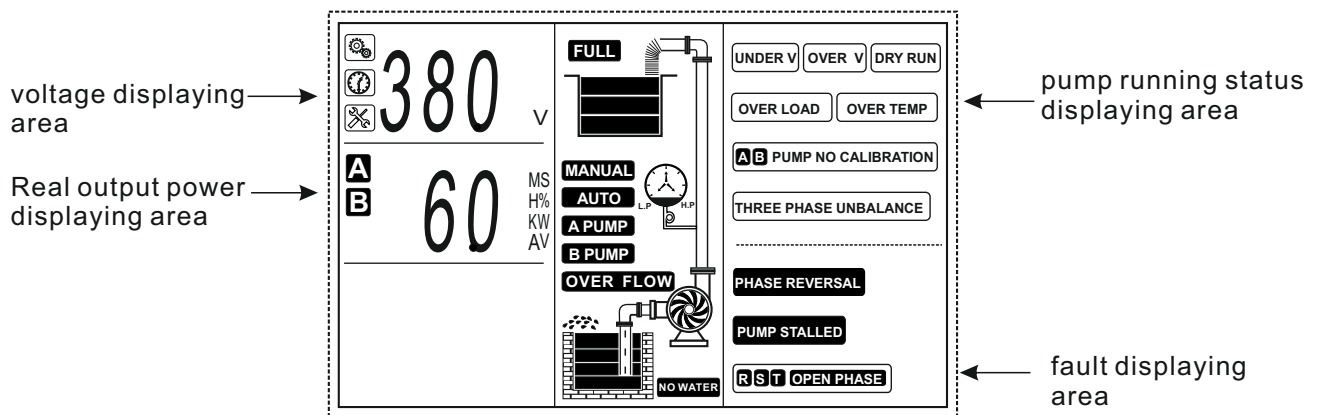
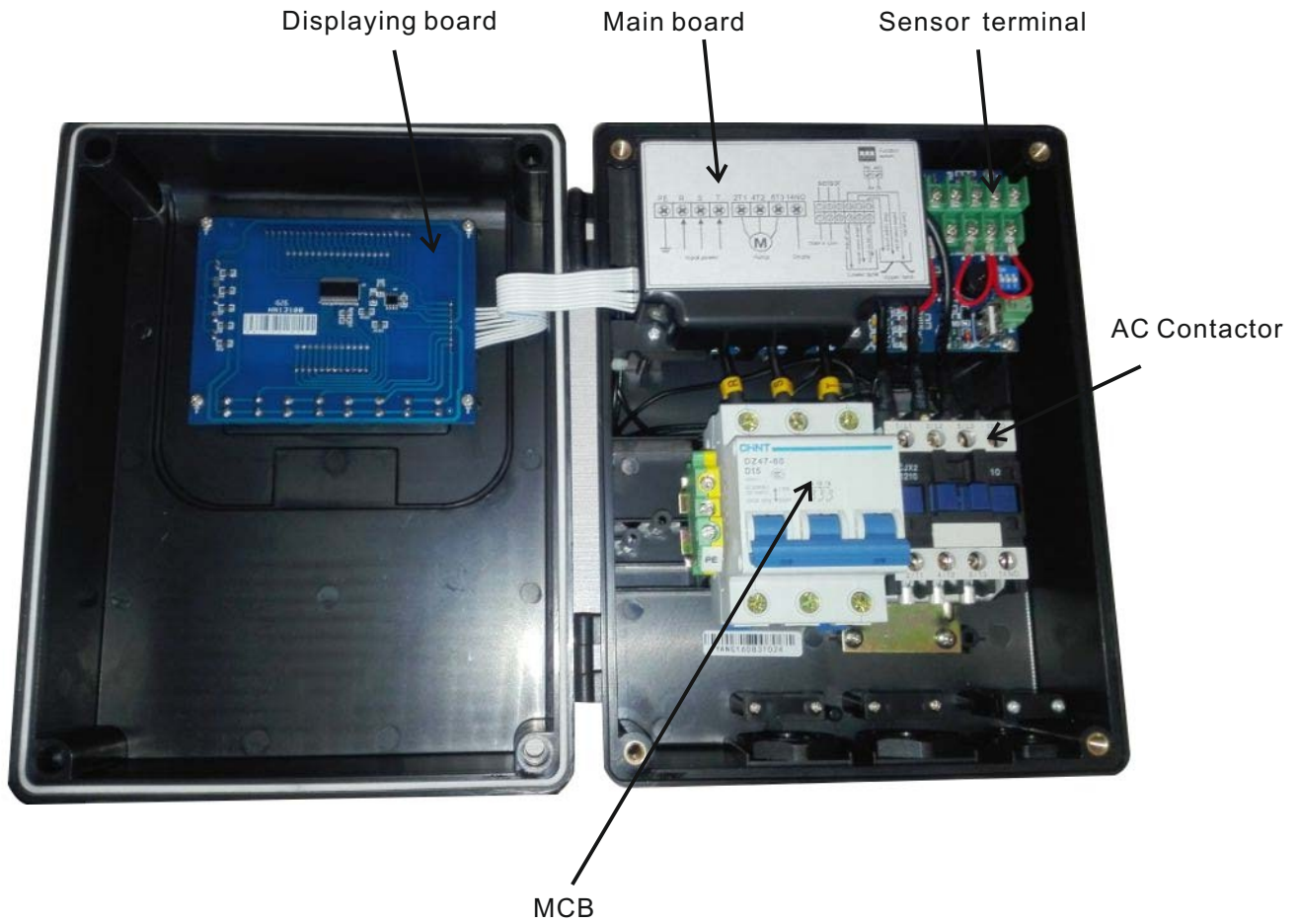

The following chart shows main technical parameters of The product

Main technical characteristic													
Control characteristic	double liquid level control												
	pressure control												
Control method	Manual / Auto												
Liquid level control characteristic	pulse electrode probe & float switch												
Pressure control characteristic	pressure switch (n/c) & pressure tank												
Main technical data													
Rated output power	0.75-4KW(1HP-5.5HP) 5.5-11KW(7.5-15HP) 15KW (20HP)												
Rated input voltage	refer to the nameplate												
Trip response time of over load	5sec-5min												
Trip response time of open phase	<2sec												
Trip response time of short circuit	<0.1sec												
Trip response time of under / over voltage	<5sec												
Trip response time of dry run	6sec												
Recovery time of over load	30min												
Recovery time of under / over voltage	5min												
Recovery time of dry run	30min												
Trip voltage of over voltage	115% of the rated input voltage												
Trip voltage of under voltage	80% of the rated input voltage												
Liquid level transfer distance	≤150m												
Protection function	<table border="0"> <tr> <td>Dry run</td> <td>Pump stalled</td> </tr> <tr> <td>Over load</td> <td>Short circuit</td> </tr> <tr> <td>Transient surge</td> <td>Over temp</td> </tr> <tr> <td>Under voltage</td> <td>Three phase unbalance</td> </tr> <tr> <td>Over voltage</td> <td>Phase reversal</td> </tr> <tr> <td>Open phase</td> <td>Repeated start</td> </tr> </table>	Dry run	Pump stalled	Over load	Short circuit	Transient surge	Over temp	Under voltage	Three phase unbalance	Over voltage	Phase reversal	Open phase	Repeated start
Dry run	Pump stalled												
Over load	Short circuit												
Transient surge	Over temp												
Under voltage	Three phase unbalance												
Over voltage	Phase reversal												
Open phase	Repeated start												
Main installation data													
Working temperature	-25°C -- +55°C												
Working humidity	20% - 90%RH, no drips concreted												
Degree of protection	IP54												
Install position	Vertical												
Unit dimensions (L x W x H)	25 x 19.7 x 11.45cm												
Unit weight (net)	1.603kg												

1.3 Controller components



Meaning of the icons shown on the LCD

Icon	Meaning/Description
	pump parameter configuration icon, when this icon appears, pump control box is in parameter adjusting manual;
	time displaying icon, when this icon appears, it means pump control box is displaying some parameter of time, eg: pump accumulative running time (unit: hour); counting down etc
	pump fault icon, when this icon appears, it means pump control box is displaying some fault information;
V	voltage
M	minute
S	second
H	hour
%	percent
A	ampere
	pump running
	pump stops running
	low pressure or lack of pressure in the pipeline or pressure tank
	high pressure or full of pressure in the pipeline or pressure tank

2 INSTALLATION

2.1 Electrical connection to the power supply line and electrical pump

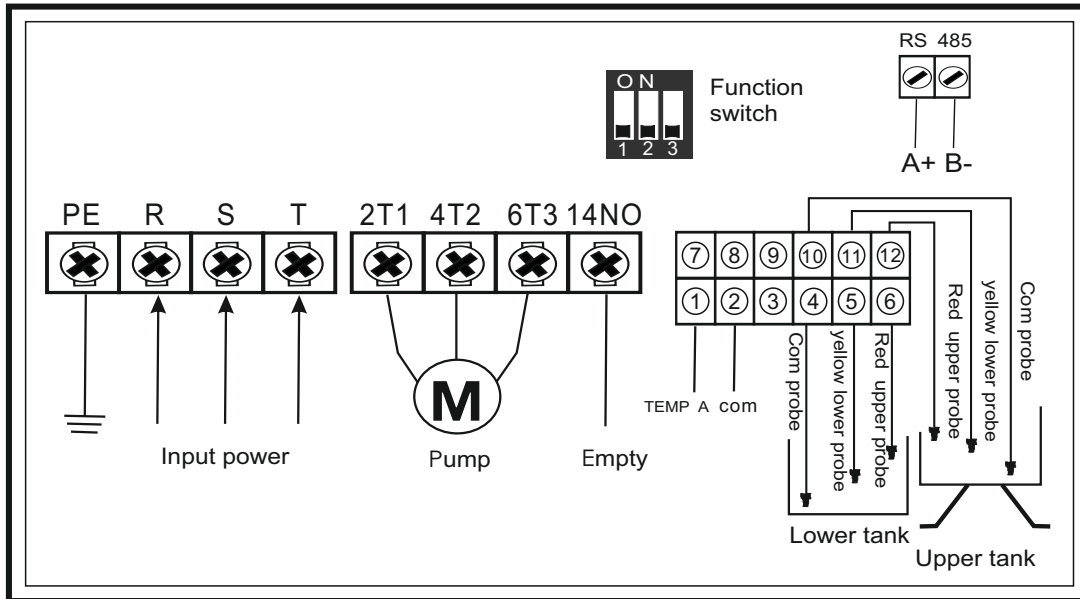

DANGER Electric shock risk

Before carrying out any installation or maintenance operation, the product should be disconnected from the power supply and one should wait at least 2 minutes before opening the appliance.



Never connect AC power to output 2T1 4T2 6T3 terminals.



Don't put wire, metal bar filaments etc into the controller.



Ensure the motor, controller and power specifications matching.





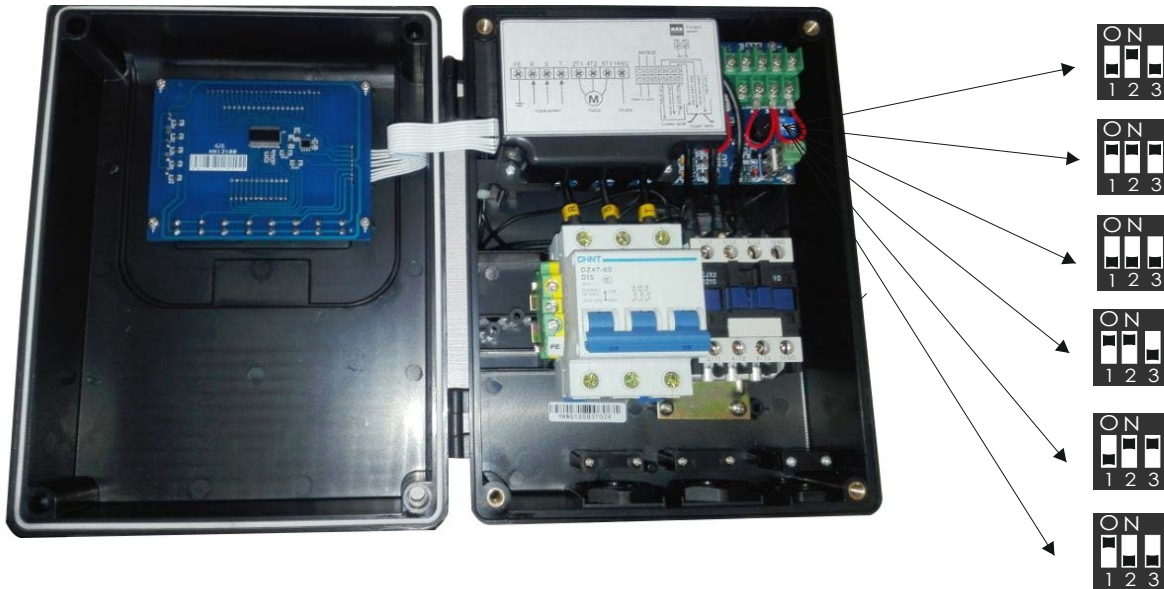

The electrical and hydraulic connections must be carried out by competent, skilled, qualified personnel.

2.2 Function switch setting

Pump users can set the function switch to meet different application requirement, before setting the function switch, the product should be disconnected from the power supply, after complete the setting, apply power to product and observe the application sign displayed on the LCD conforming to the following list.

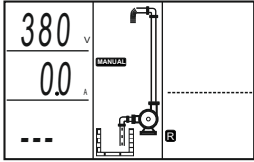

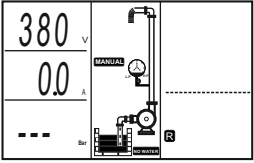
Item	Switch position	Messages & Graphic	Application
1			Applied for water supply or drainage by liquid level control through float switch or liquid sensor
2			Applied for water supply by pressure control through pressure switch & pressure tank
3			Applied for drainage by liquid level control through float switch & liquid probe

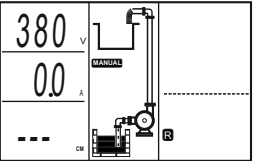
Item	Swith position	Messages & Graphic	Application
4			Applied for drainage by level transmitter
5			Applied for water supply by pressure transmitter
6			Applied for water supply by level transmitter

2.3 Connections for pump over temperature protection(when supplied with pump).

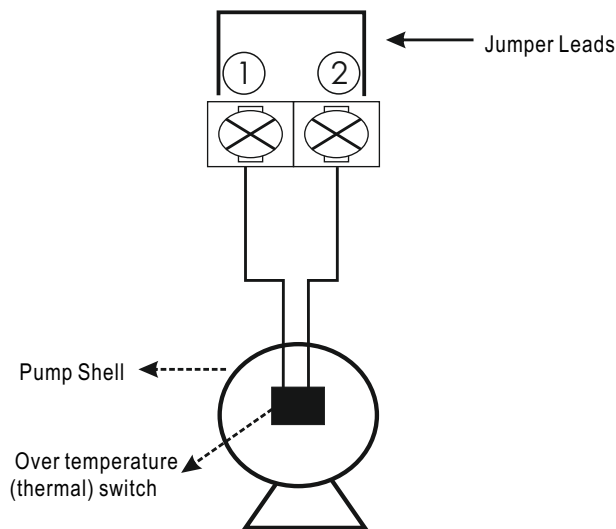

Note: to realize the pump motor winding over temperature protection, it requires that there must be over temperature switches embedded in the pump motor winding.

Note: if the pump is without over temperature switch, please use jumper to connect terminals 10 and 12.

2.4 Parameter Calibration setting & erasing

To achieve best level of protection of the pump, it is essential that parameter calibration must be done immediately after successful pump installation or pump maintenance.

Setting the parameter calibration

- Press the  key to switch to manual state, make sure the pump not running and LCD screen displaying:

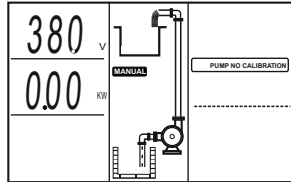

- Press the  key to run pump, confirm the pump and all pipe network in normal working state (including voltage, running ampere et); LCD screen displaying:

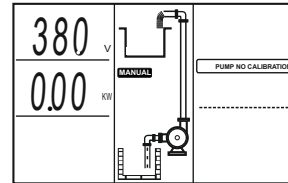

- Press the  key; The product makes a "Di" sound and starts countdown, LCD screen displaying:

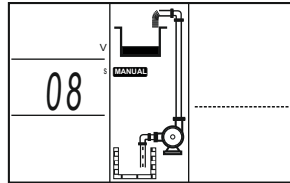

- Pump stops running and parameter calibration completed, LCD screen displaying:
product is ready for running.

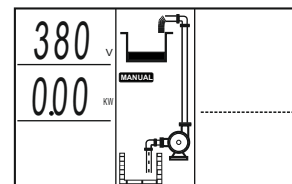

Erasing former parameter calibration

When pump is reinstalled after maintenance or new pump is installed, user must erase the former parameter calibration and a new calibration must be done.

Erasing the parameter calibration

- Press the  key to switch to manual state, make sure the pump not running and LCD screen displaying:

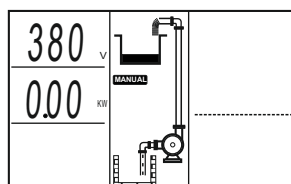

- Press the **STOP** key and release till product makes a "Di" sound, product recover the default factory setting and LCD screen displaying:

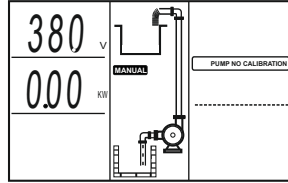

3 ELECTRICAL CONNECTION

3.1 Installing liquid probe & float switch

Liquid probe installation

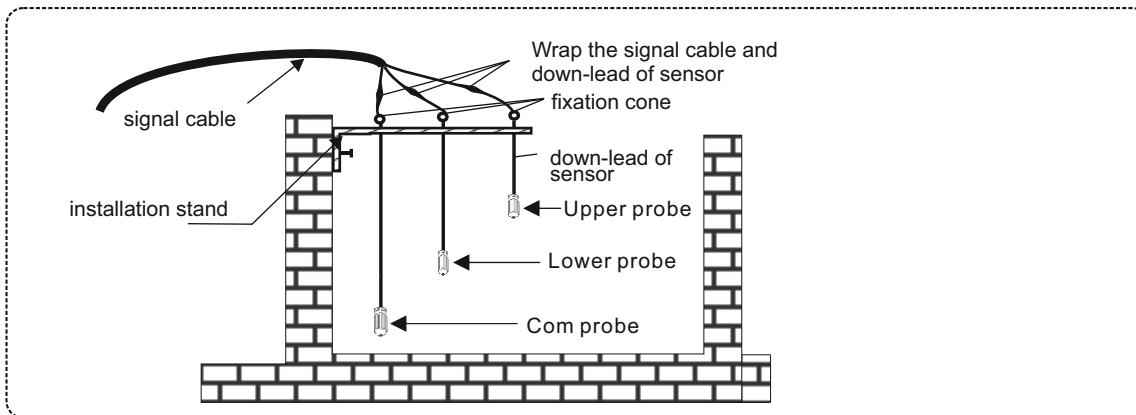

! In event of high risk of electric storms (lightning) or when liquid medium in well or tank or sump is very dirty it is recommended float switch is used.

Float switch installation

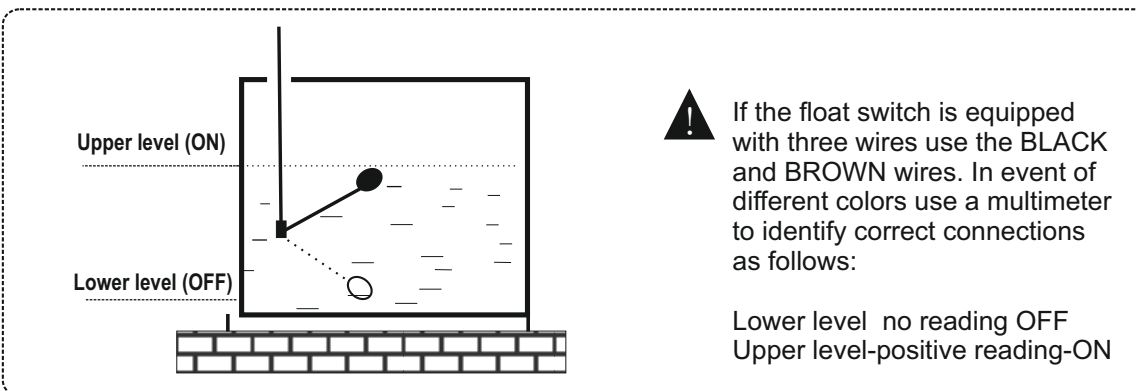

! DO NOT ENCASE SENSOR LEADS, FLOAT SWITCH WIRE OR SIGNAL CABLES IN METAL PIPES. USE PVC OR PE TUBING.

3.2 Electrical connection for different application

3.2.1 Water supply by liquid level control through float switch or liquid probe

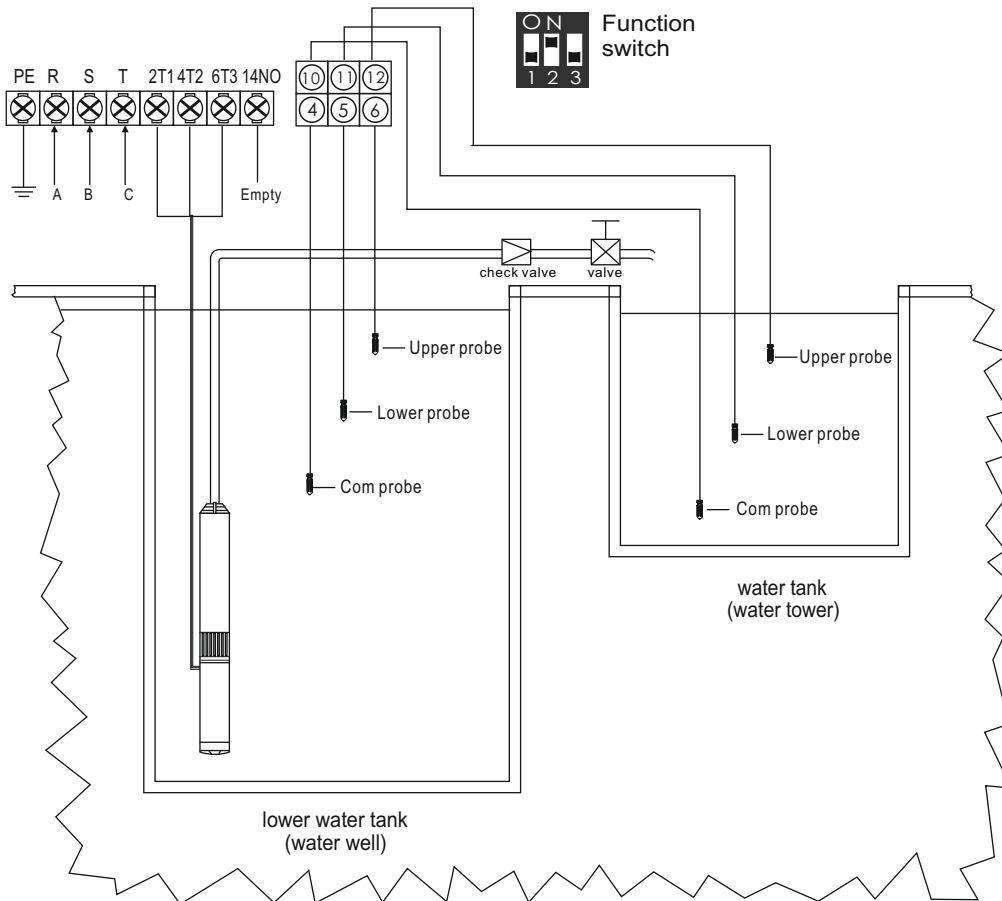
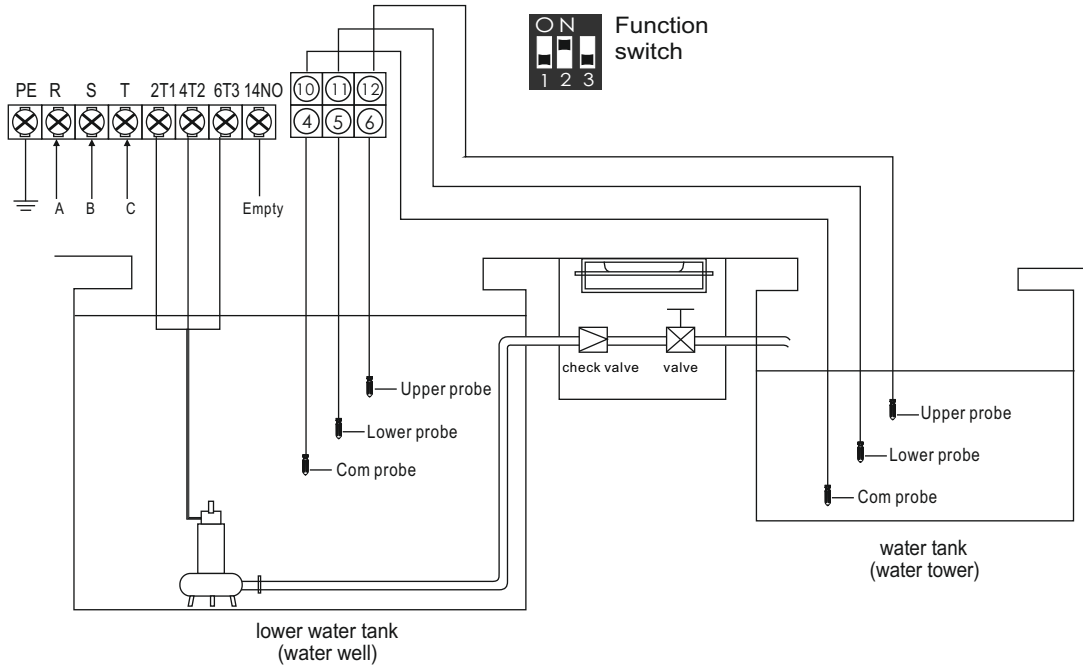

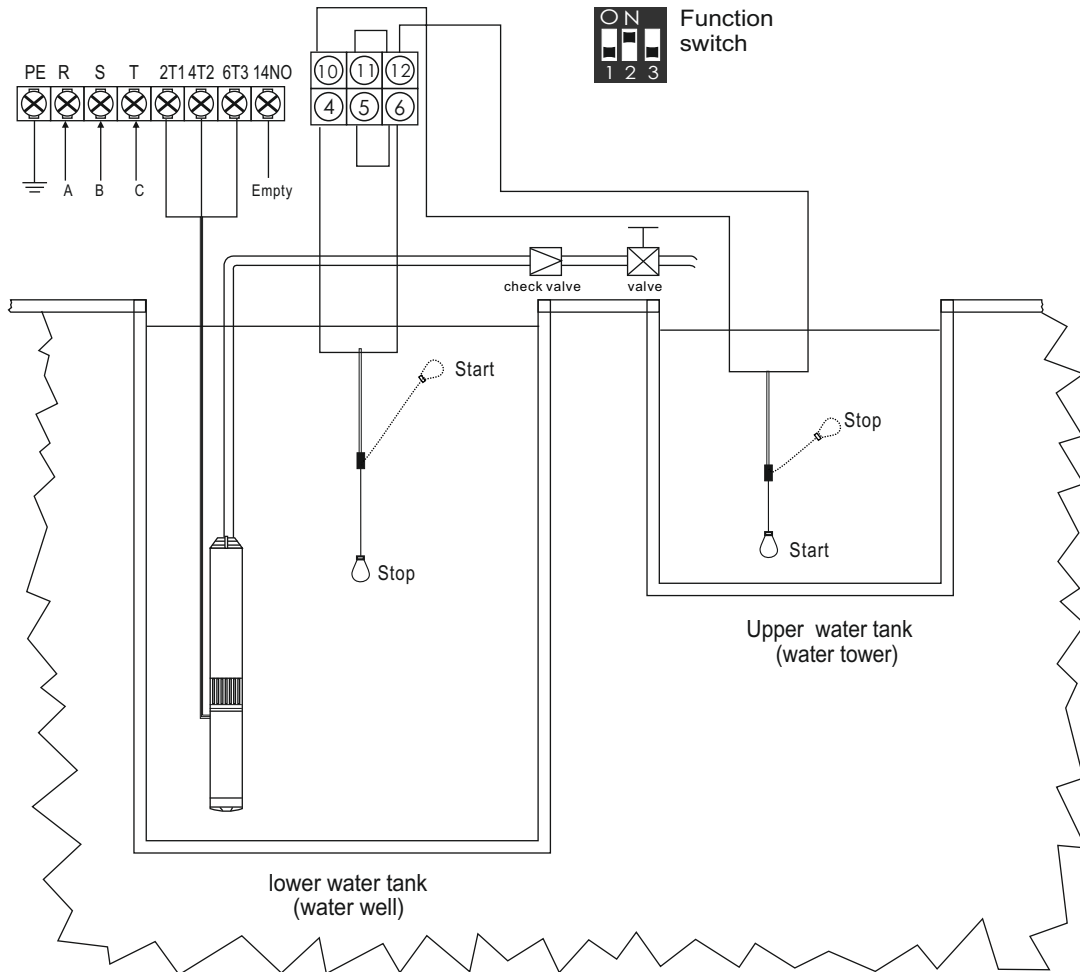
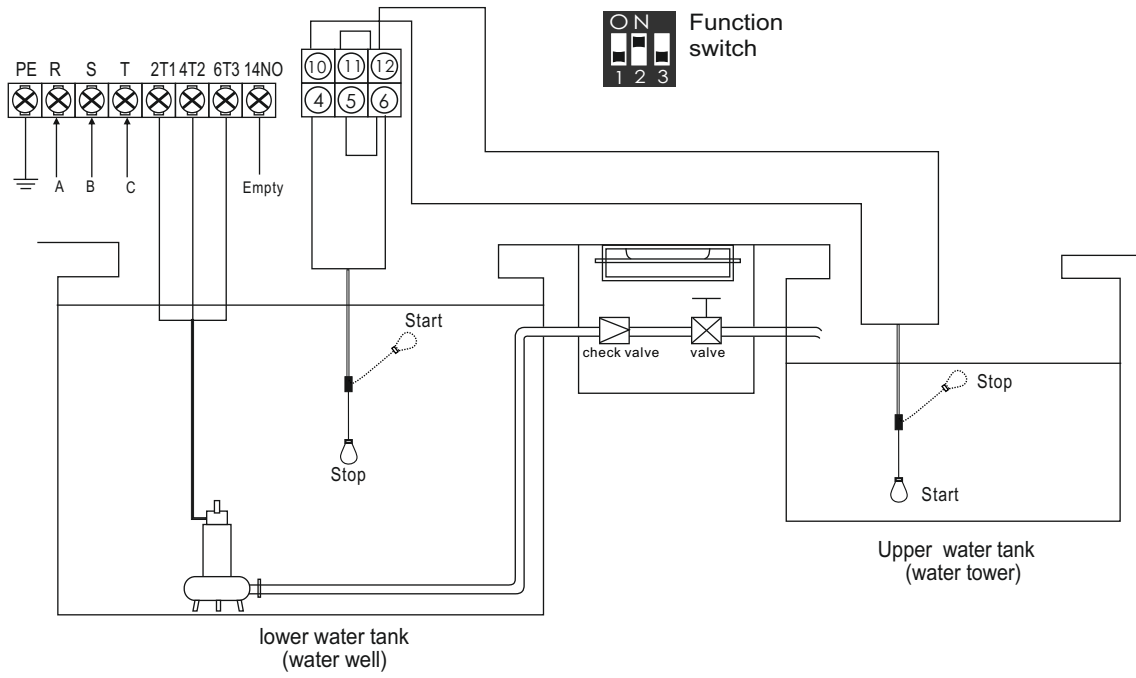

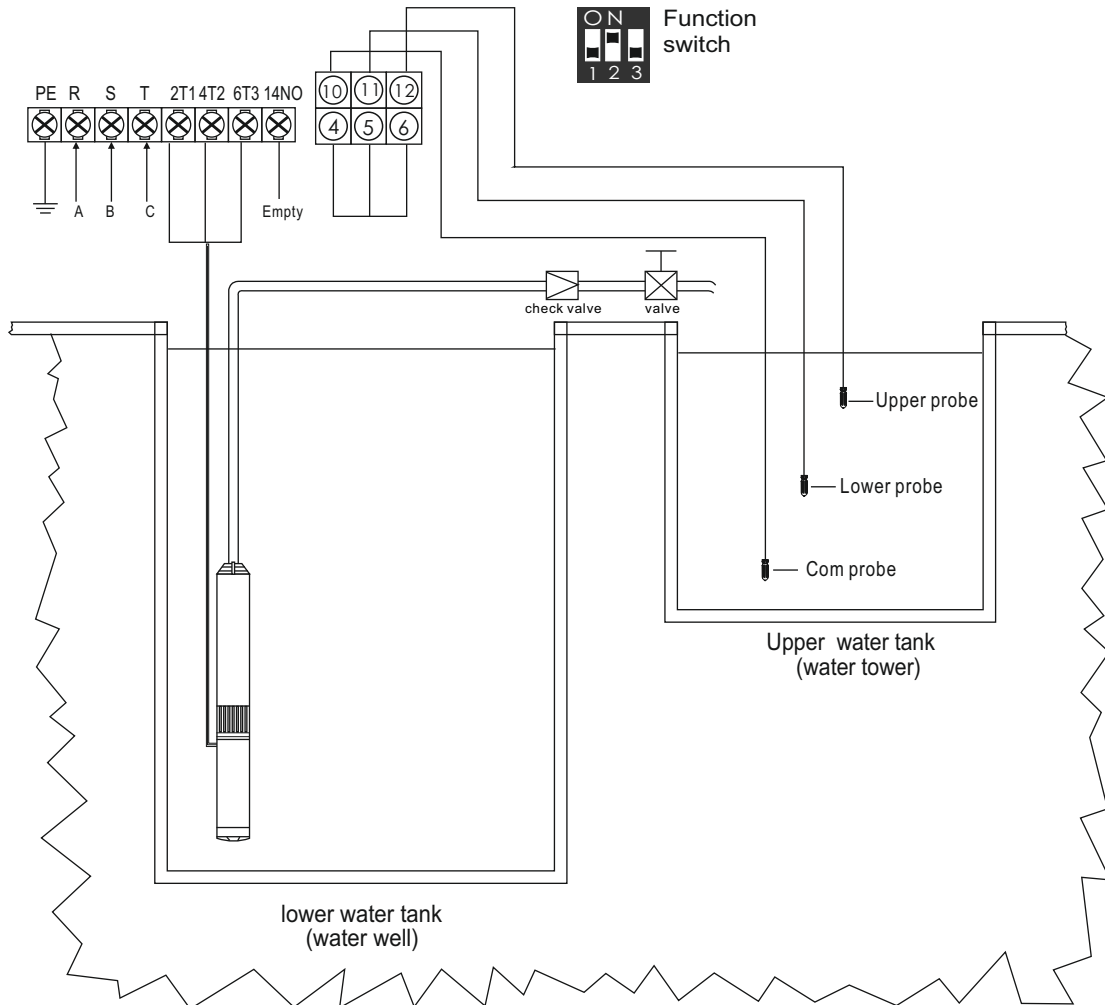
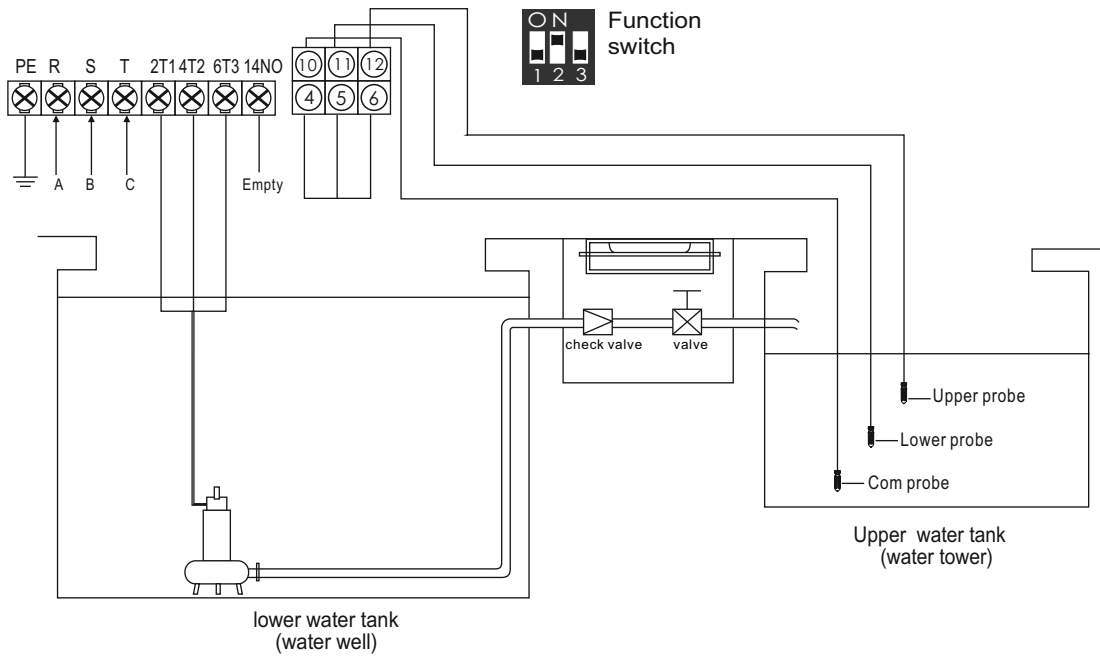

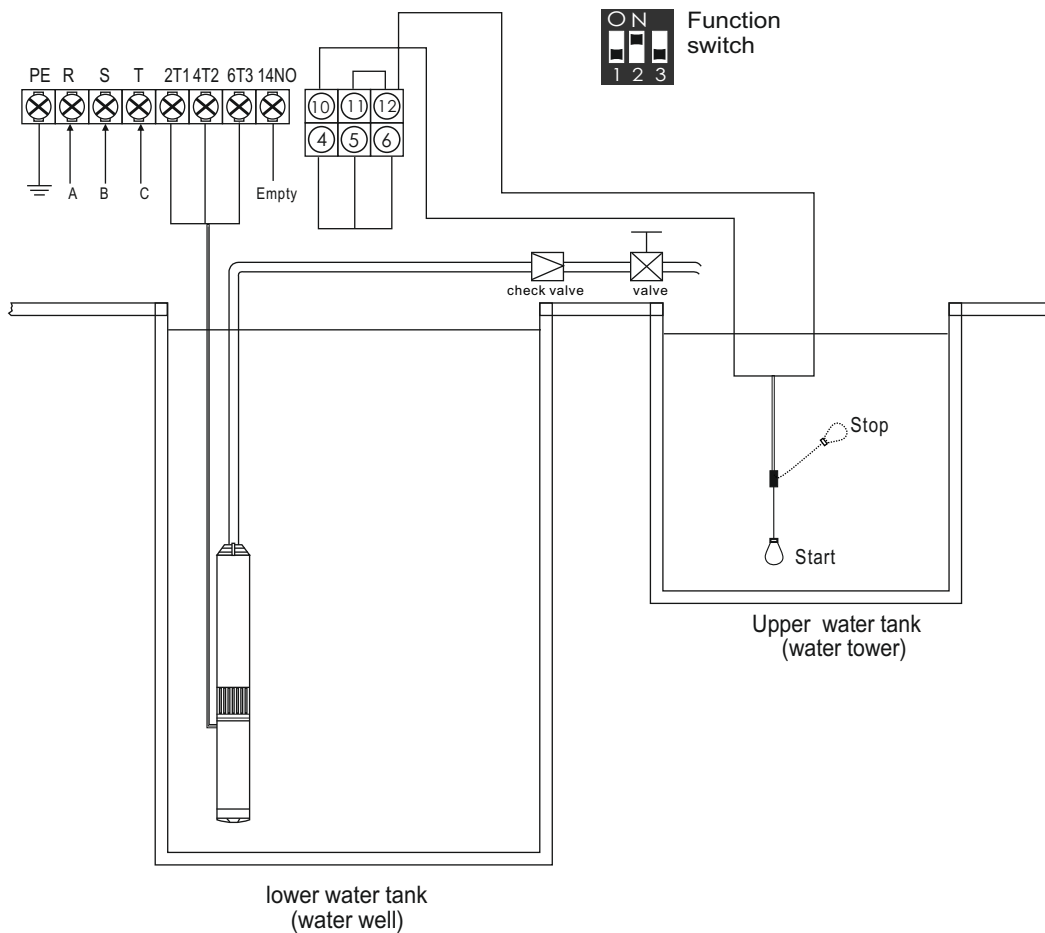
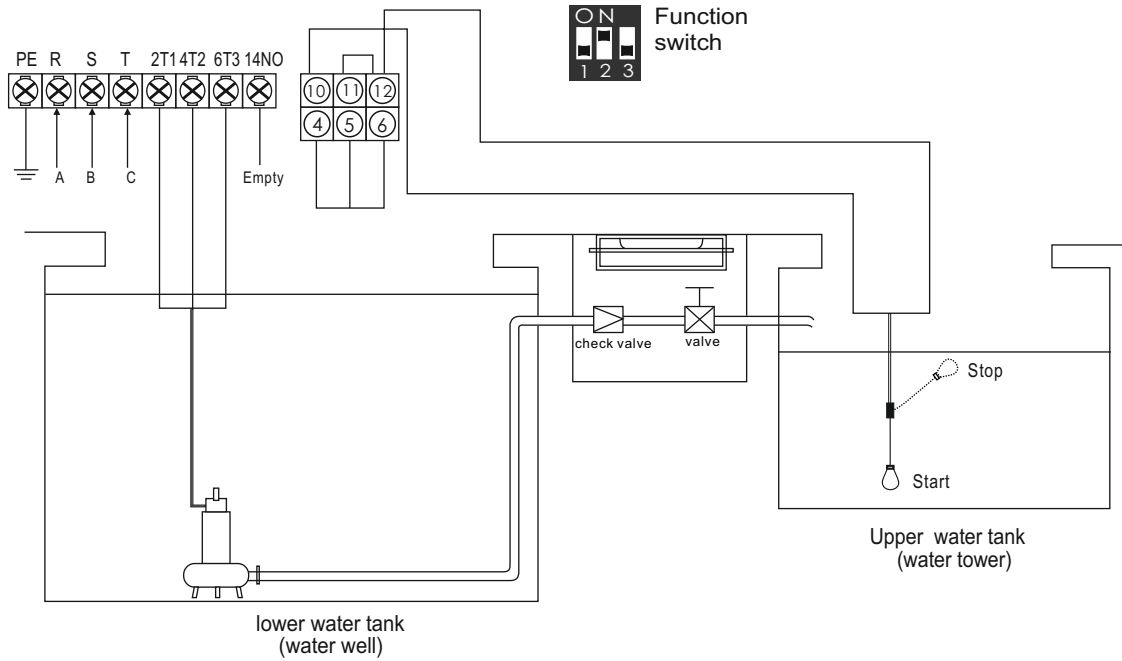

1). Starting condition

liquid level in the water tank is below Lower probe (float switch: Down level) and liquid level in the water well is above Lower probe (float switch: Up level), the product will run pump;

2). Stop condition

liquid level in the water tank reaches Upper probe (float switch: Up level) or liquid level in the water well is below Lower probe (float switch: Down level); the product will stop pump running;

3). The probe / sensor free in the water well

as the product has reliable and automatic stop function against pump dry-run (dewatering), if it is used in submersible pump for deep well, pipeline pump or other situations when it is inconvenient to install lower liquid probe in the well, pump users can put second line terminals in short circuit, which minimize the troubles and costs.

4). Meaning of the messages & graphic shown on the LCD screen

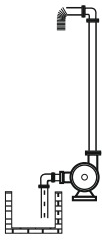
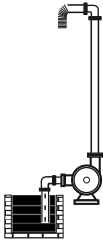
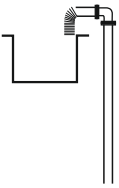
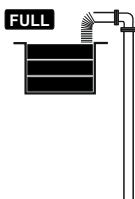
Messages & Graphic	Description
	Lack of water in water well
	Full of water in water well
	Lack of water in water tank
	Full of water in water tank

3.2.2 Water supply by pressure control through pressure switch & pressure tank

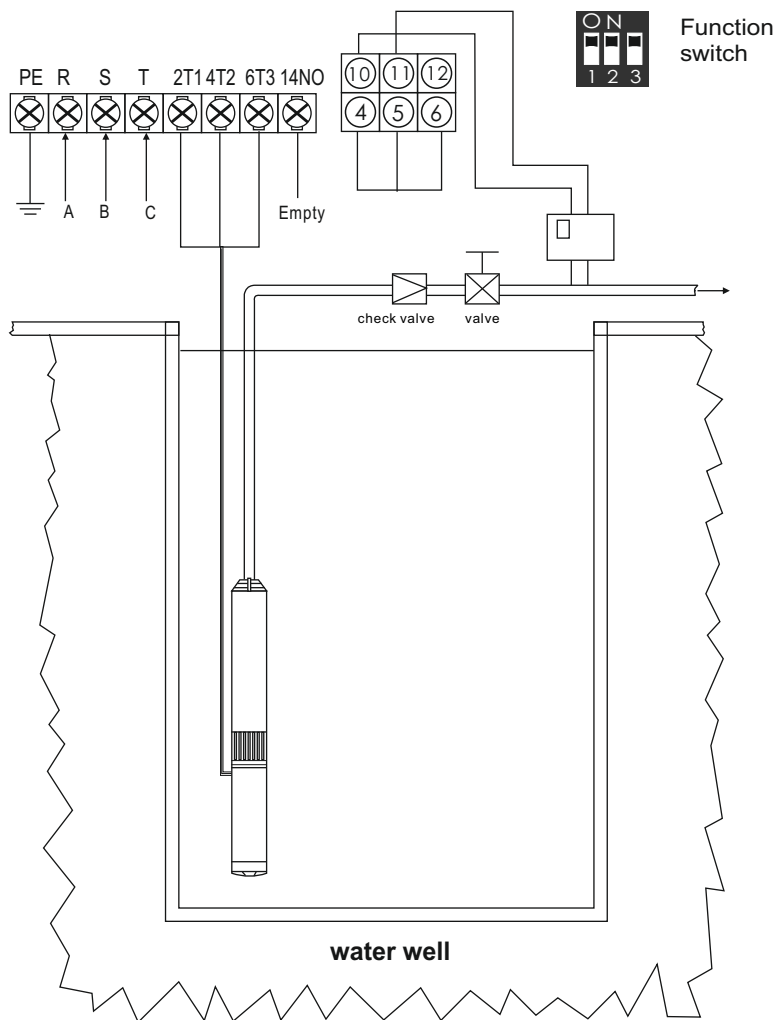
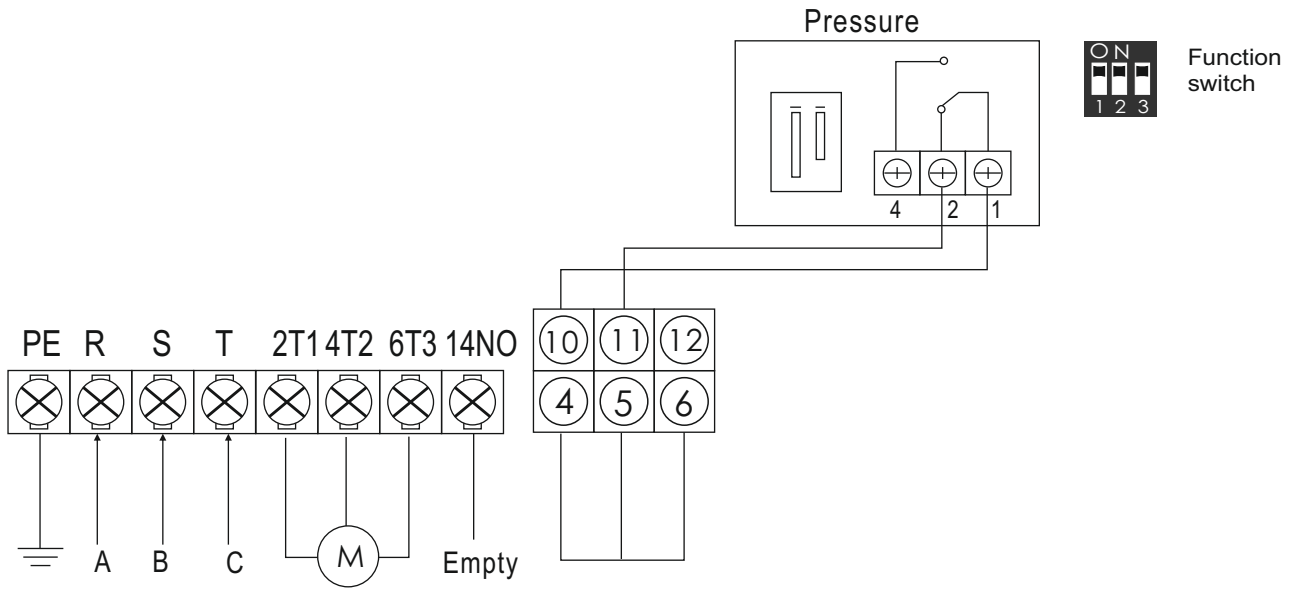

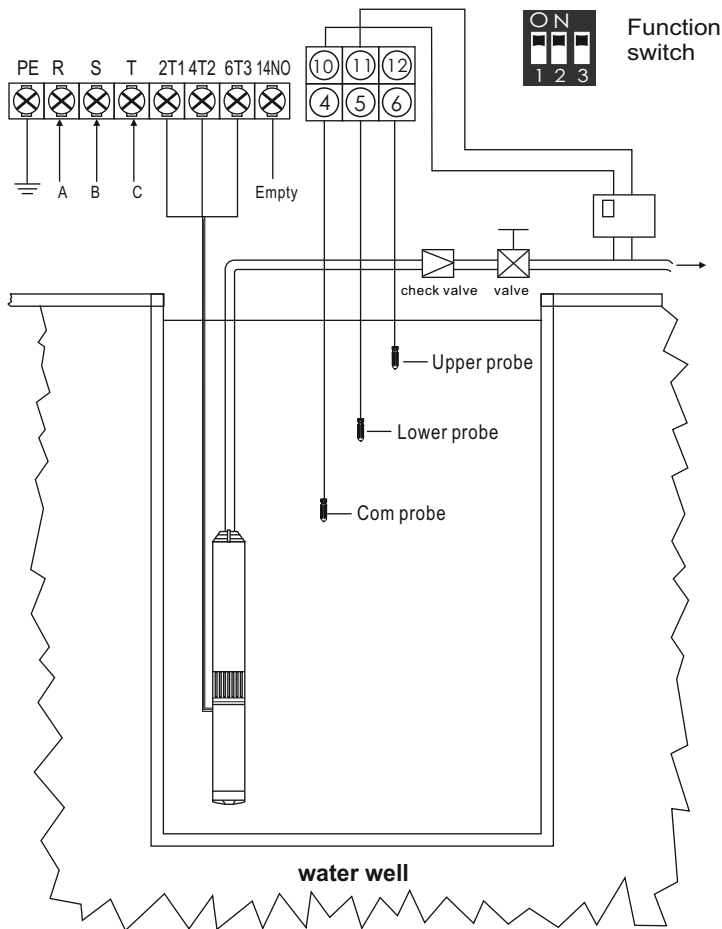
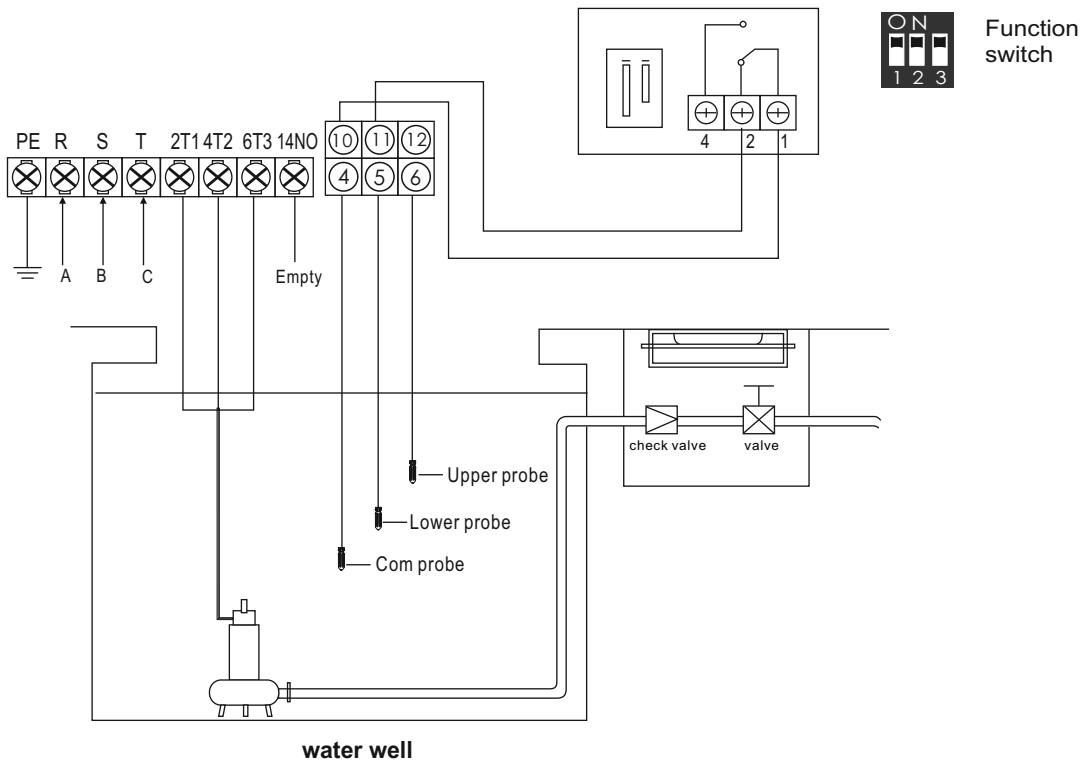

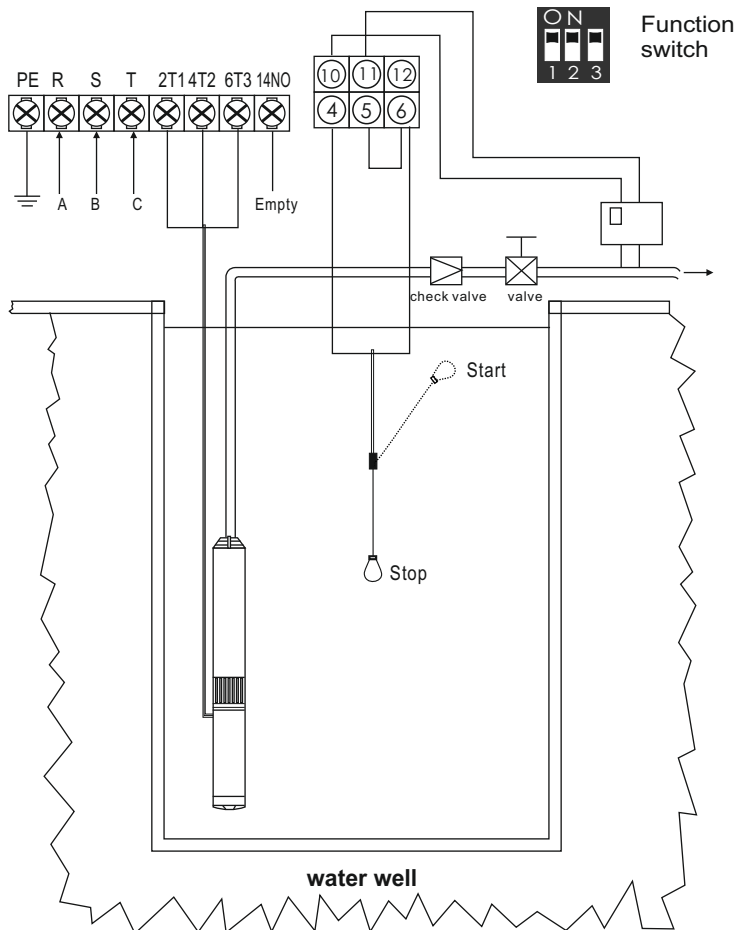
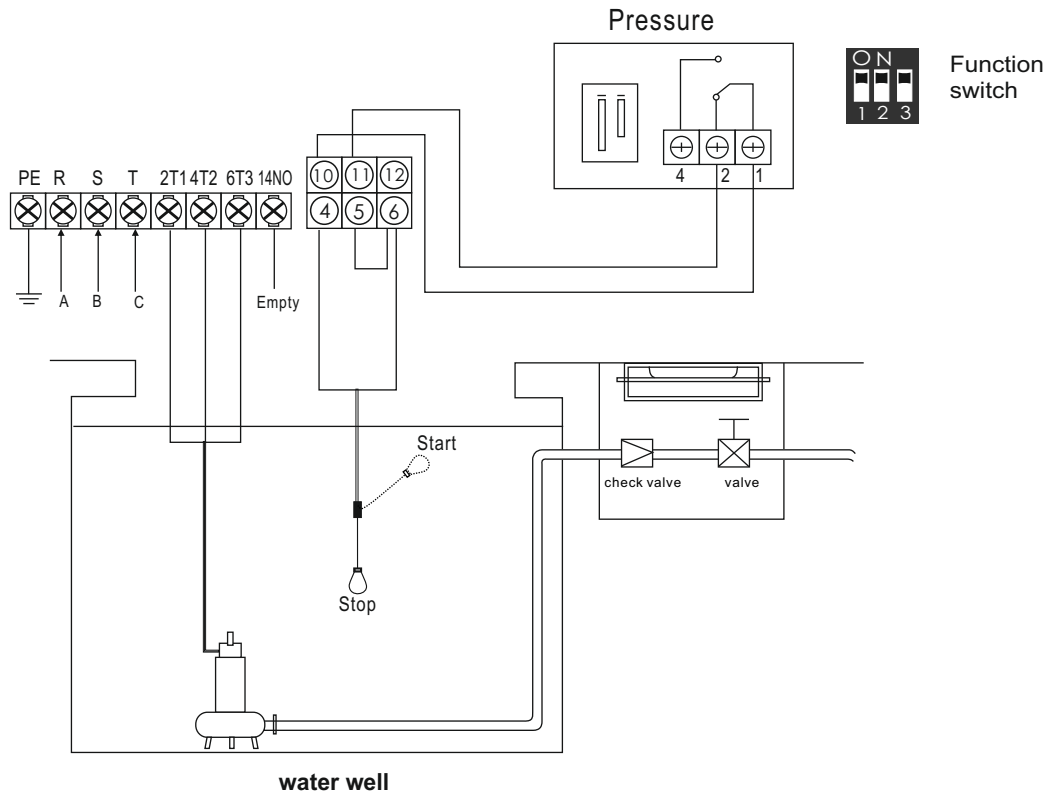

1). Starting condition

there is no pressure in the pipeline or pressure tank, contacting point of pressure switch is ON and liquid level in the water well is above Lower probe (float switch: Up level), the product will run pump;

2). Stop condition

there is full pressure in the pipeline or pressure tank, contacting point of pressure switch is OFF, the product will stop pump running;

Note: pressure switch with N/C (normal close) contacting point:
 no pressure, contacting point is ON; meet the pressure setting, contacting point is OFF

3). The probe / sensor free in the water well

as the product has reliable and automatic stop function against pump dry-run (dewatering), if it is used in submersible pump for deep well, pipeline pump or other situations when it is inconvenient to install lower liquid probe in the well, pump users can put second line terminals in short circuit, which minimize the troubles and costs.

4). Meaning of the messages & graphic shown on the LCD screen

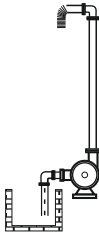
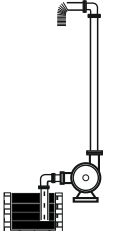
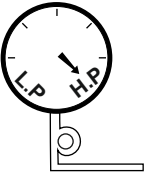
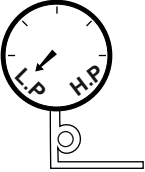
Messages & Graphic	Description
	<p>Lack of water in water well</p>
	<p>Full of water in water well</p>
	<p>Full of pressure in pipeline or pressure tank</p>
	<p>Lack of pressure in pipeline or pressure tank</p>

3.2.3 Drainage by liquid level control through float switch & liquid probe

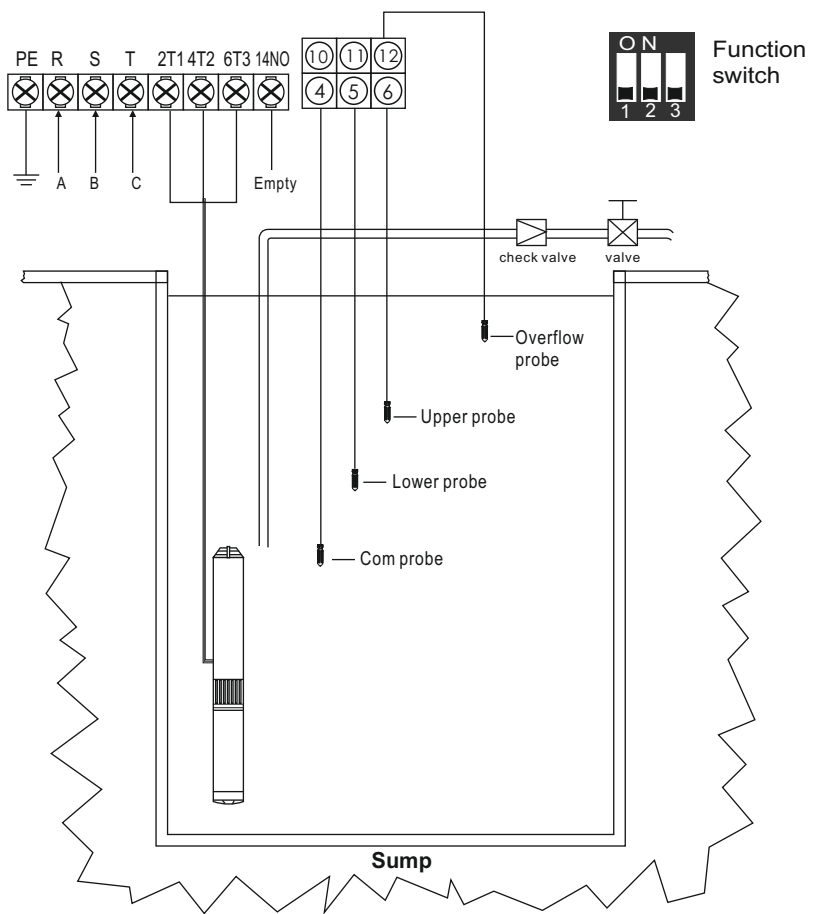
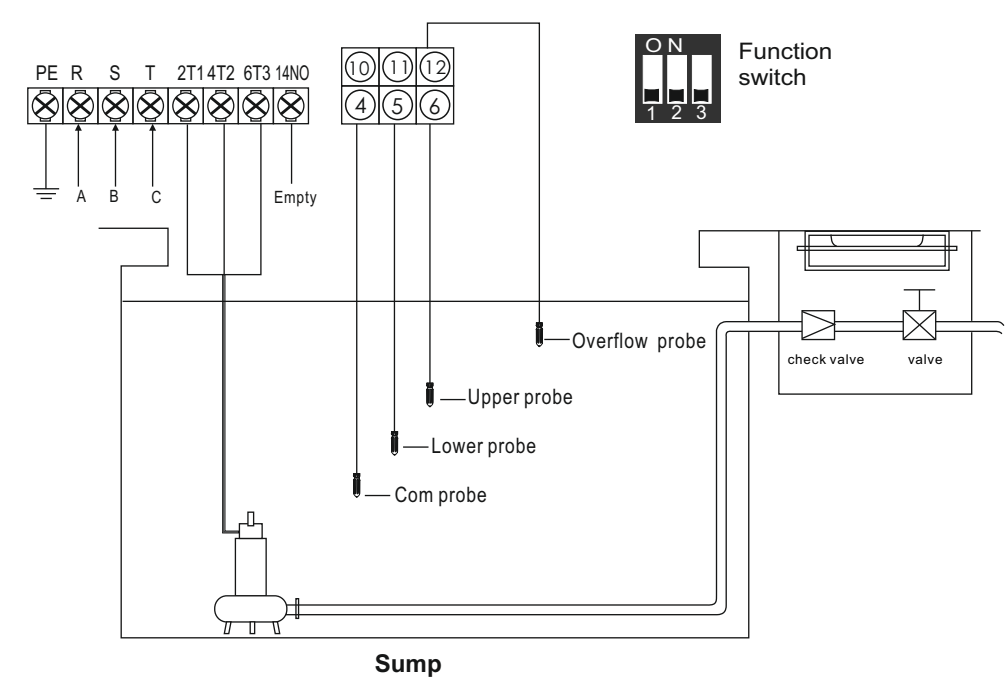

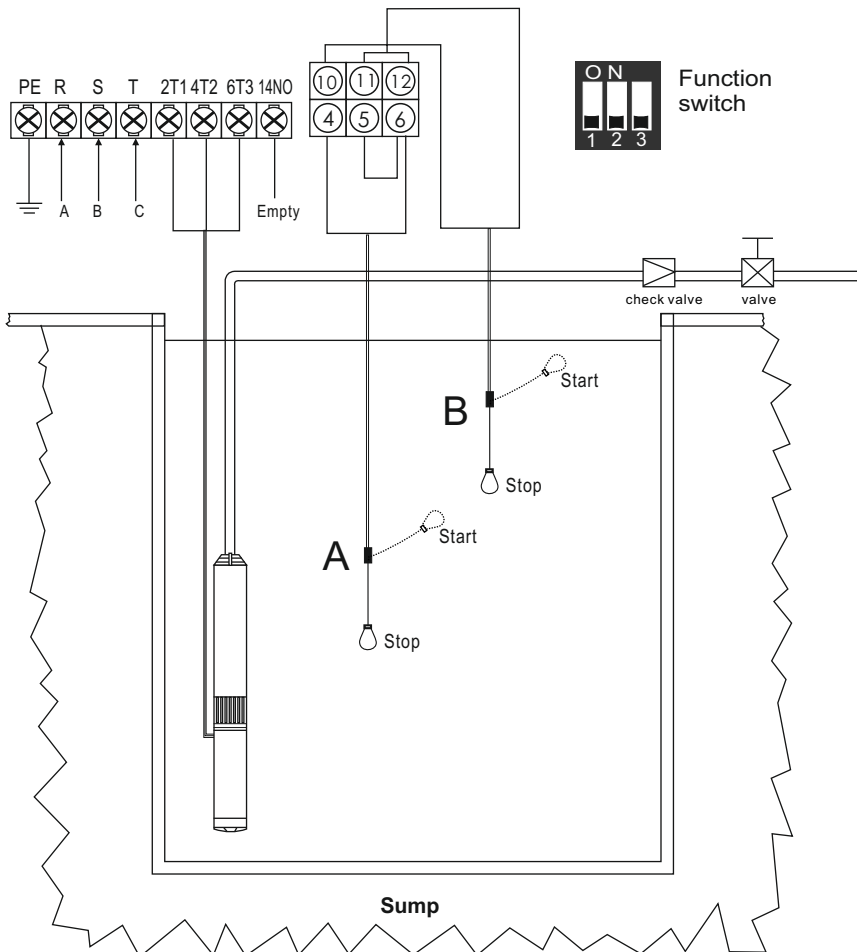
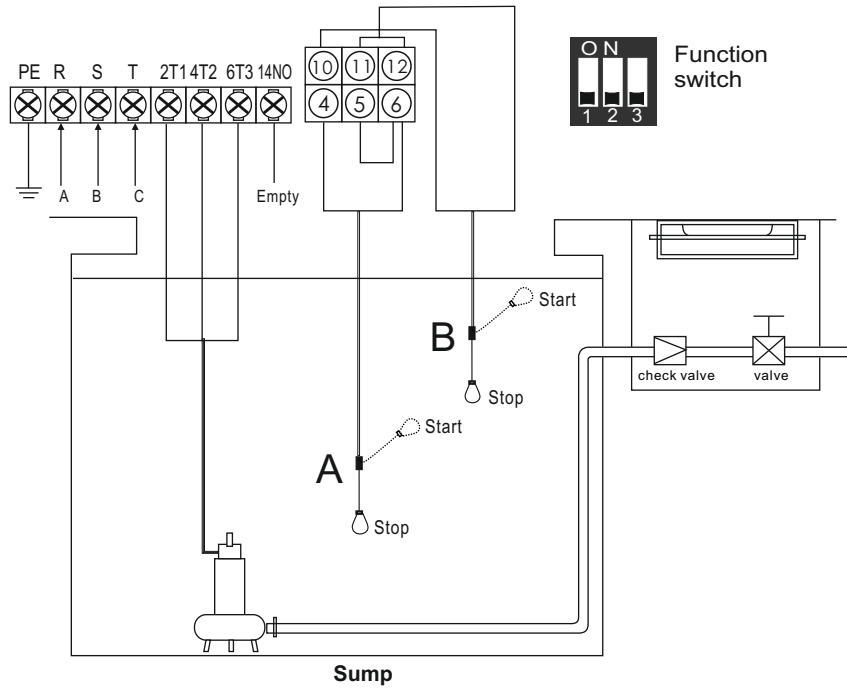

1). Starting condition

liquid level in the sump reaches Upper probe (float switch A: Up level), the product will run pump;

2). Stop condition

liquid level in the sump is below Lower probe (float switch A: Down level), the product will stop pump running;

3). Over Flow alarm

when pump is draining water, liquid level in the sump is still rising to Overflow probe (float switch B: Up level), the product will sound the overflow alarm to warn pump user to take further action.

4). Meaning of the messages & graphic shown on the LCD screen

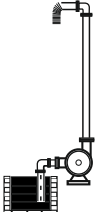
Messages & Graphic	Description
	Lack of water in sump
	Overflow in sump

3.2.4 Drainage by level transmitter (Installing level transmitter)

Technical parameter

The following chart shows the main the technical parameters of level transmitter

Main technical data	Value
Measure Range	0-2 meter depth for more depth range, please contact manufacturer
Power Supply	5 ± 0.5 VDC
Output Signal	0.5-4.5V
Accuracy	$\pm 2\%$ FS (-10°C 100°C)
Overload Pressure	2×RP (rated pressure)
Broken Pressure	3×RP (rated pressure)
Insulation	≥ 10 MΩ@50V
Response Time	<10ms
Wires	Three-wire
Elec. connector	Packard
Pressure Port	G1/2
Shell Protection	IP65

Dimension & Pin definition

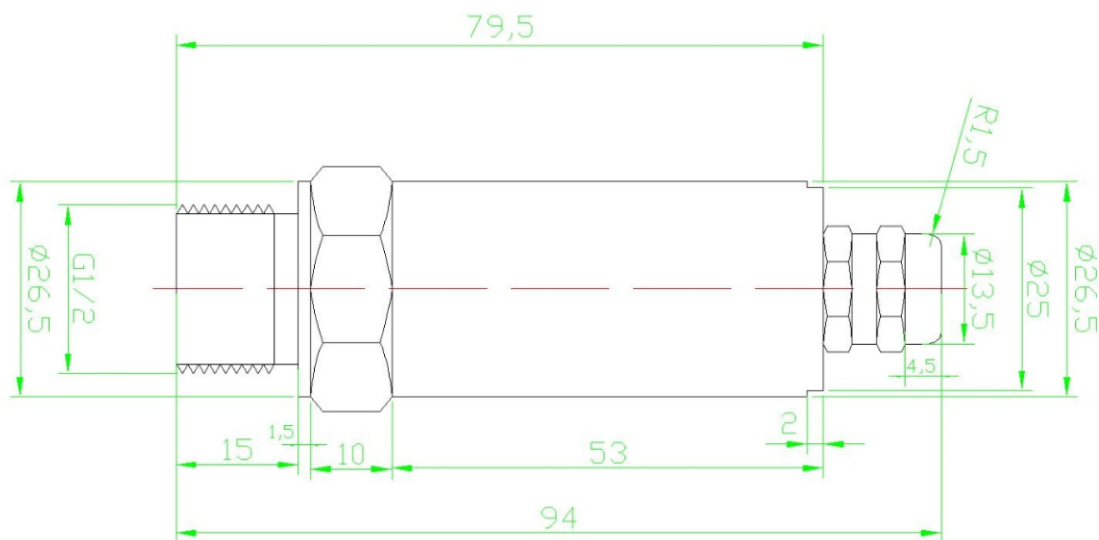

Pin definition		
a	VOUT	Yellow color wire
b	VCC	Red color wire
c	GND	Black color wire

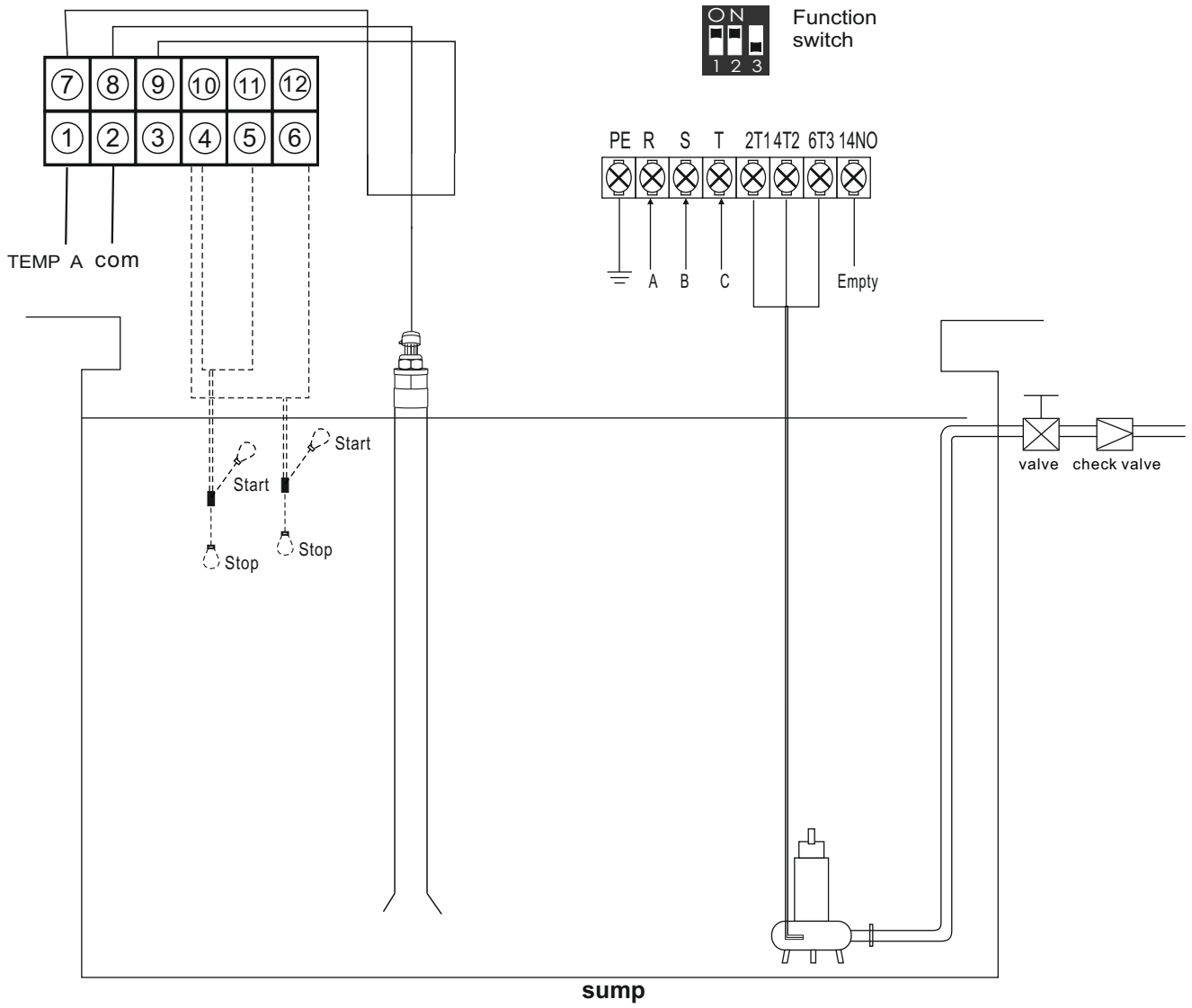

3.2.5 Water supply by pressure control through pressure transmitter (Installing pressure transmitter)

Technical parameter

The following chart shows the main the technical parameters of pressure transmitter

Main technical data	Value
Measure Range	0-2. 5Mpa
Power Supply	5±0. 5VDC
Output Signal	0. 5-4. 5V
Accuracy	±2%FS (-10℃100℃)
Overload Pressure	2×RP (rated pressure)
Broken Pressure	3×RP (rated pressure)
Insulation	≥10MΩ@50V
Response Time	<10ms
Wires	Three-wire
Elec. connector	Packard
Pressure Port	G1/2
Shell Protection	IP65

Dimension & Pin definition

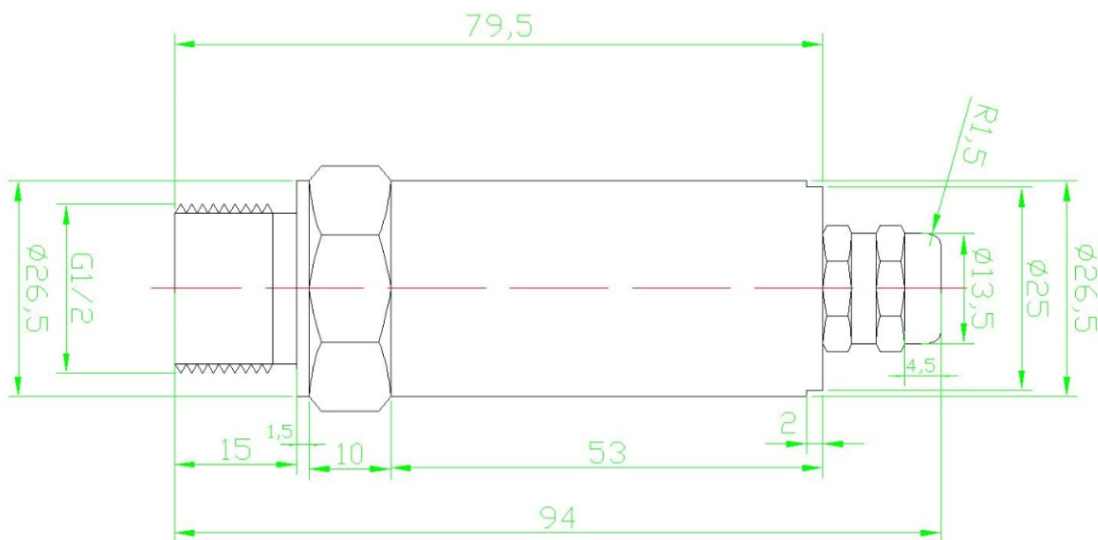

Pin definition		
a	VOUT	Yellow color wire
b	VCC	Red color wire
c	GND	Black color wire

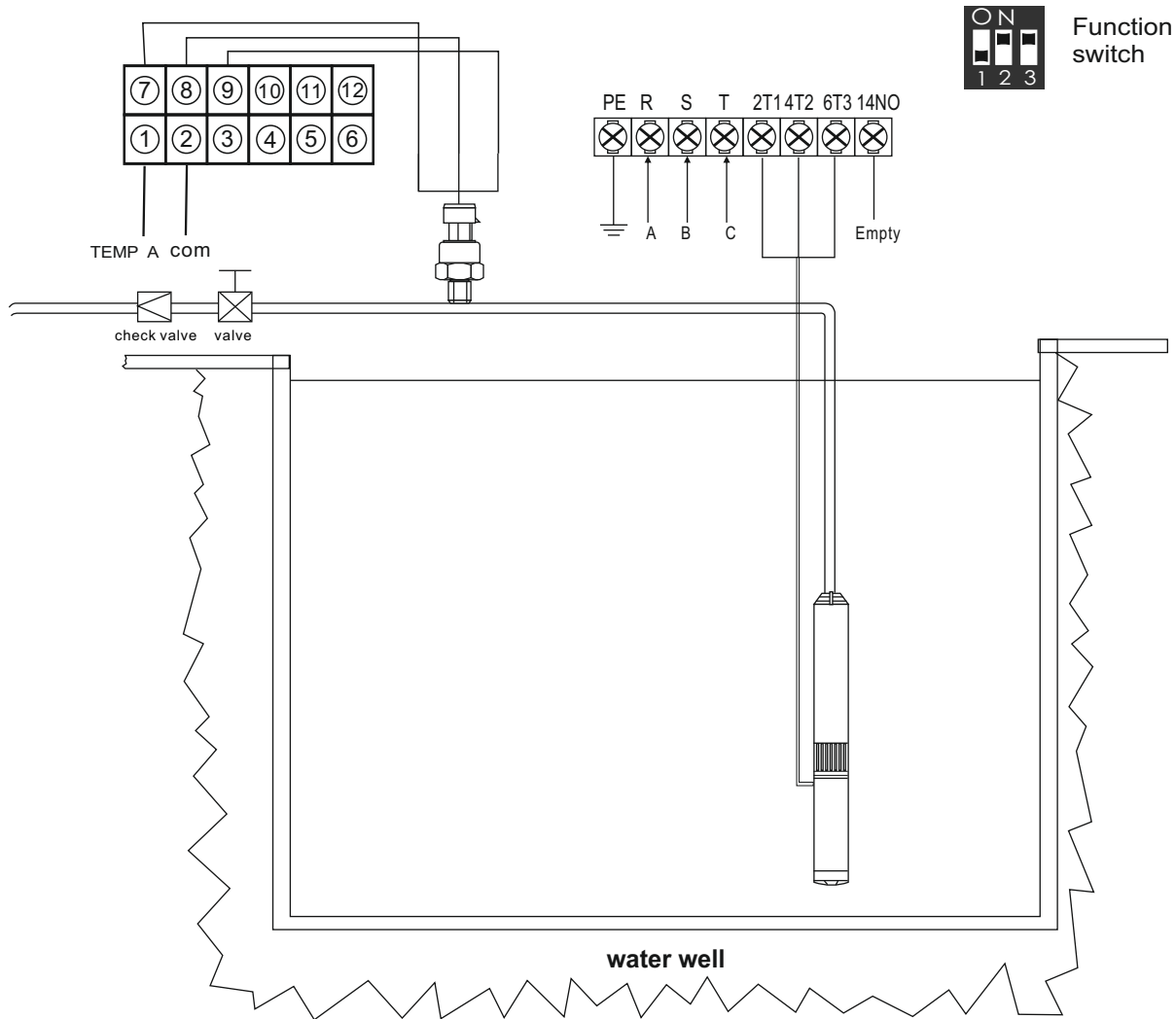

3.2.6 Water supply by level transmitter (Installing level transmitter)

Technical parameter

The following chart shows the main the technical parameters of level transmitter

Main technical data	Value
Measure Range	0-2 meter depth for more depth range, please contact manufacturer
Power Supply	5 ± 0.5 VDC
Output Signal	0.5-4.5V
Accuracy	$\pm 2\%$ FS (-10°C-100°C)
Overload Pressure	2×RP (rated pressure)
Broken Pressure	3×RP (rated pressure)
Insulation	$\geq 10M\Omega @ 50V$
Response Time	<10ms
Wires	Three-wire
Elec. connector	Packard
Pressure Port	G1/2
Shell Protection	IP65

Dimension & Pin definition

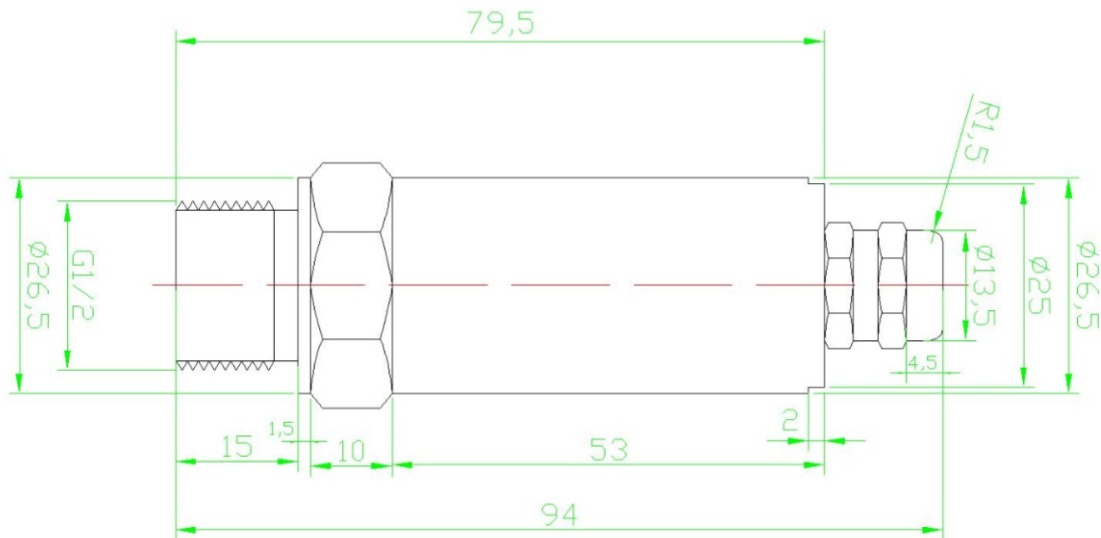

Pin definition		
a	VOUT	Yellow color wire
b	VCC	Red color wire
c	GND	Black color wire

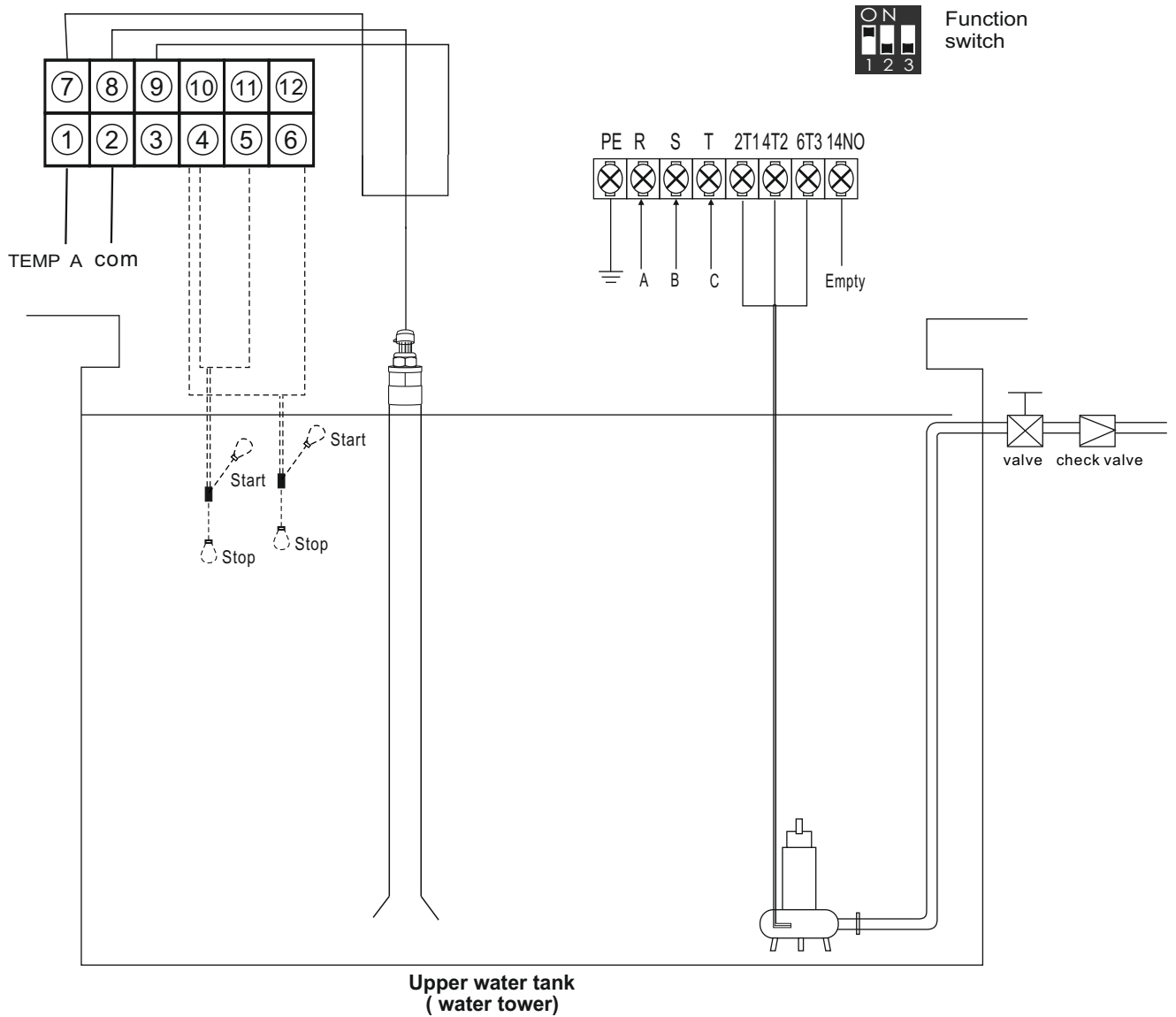
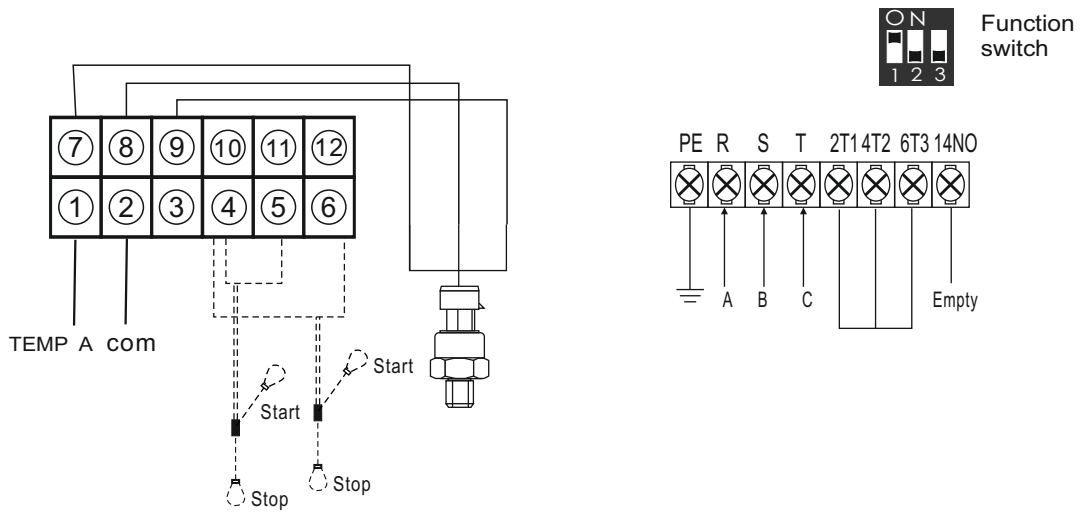

4 BASIC OPERATION

4.1 Switching to MANULA mode

Press the  key to switch to manual state, product is under the manual control state; under manual state, press the  key to run pump; press the  key to stop pump running;

Note: under manual state, the product can not receive the signal from liquid level probe or pressure switch.

4.2 Switching to AUTO mode

Press the  key to switch to auto state, product is under the auto control state; under auto state, product will run or stop the pump according to the signal from liquid level probe or pressure switch.

Note: under auto state, if the pump is running and pump user wants to stop pump running compulsory, press the  key to switch to manual state and pump stops running;

Note: under auto state, if the input power being cut off and recovery power again, the product will enter operation state after 10seconds countdown;

Note: no matter the product is under auto or manual state, if the input power being cut off and recovery power again, the product will resume its operation state as the operation state before power being cut off;

4.3 Pump protection

During pump running, if dry run, over load, under voltage, over voltage etc failures happened, the product will immediately shut down the pump running and automatically execute a check for restarting conditions after a built in time delay has elapsed. The product will not recover automatically until all the abnormal situation(s) have been cleared.

If pump stalled, open phase etc serious failures happened, pump user must check the pump and motor immediately and repair the pump.

4.4 Pump last five failure record displaying

The product can memorize the last five failures of pump, so it is very convenient for the pump users to analyse the pump running conditions.

Displaying the pump last five failure record

- Press the  key to switch to manual state, make sure the pump not running and LCD screen displaying:

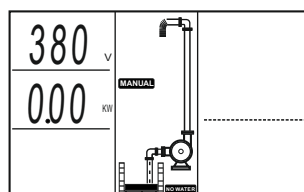

- Hold pressing **STOP** key and press **AUTO/MANUAL** key, the product makes a "Di" sound, the product displays pump failure record;
- Press **STOP** key to quit the failure record displaying;

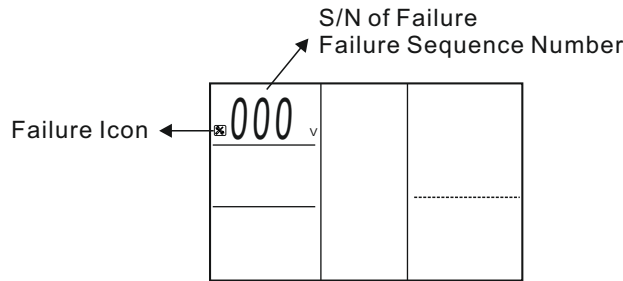

THE LATEST FAILURE IS PUMP STALLED

4.5 Pump accumulative running time displaying

The product can memorize how many hours of pump running, so it is very convenient for the pump users to analyse the pump running conditions and do maintenance

Displaying the pump accumulative running time

- Press the **AUTO/MANUAL** key to switch to manual state, make sure the pump not running and LCD screen displaying:

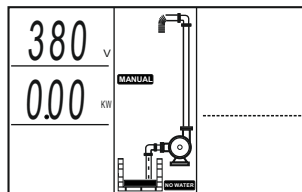

- Hold pressing **STORE/SET** key and press **STOP** key, the product makes a "Di" sound, the product displays pump failure record;

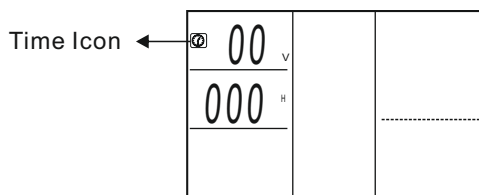

THE PUMP HAS RUN FOR 23 HOURS

- Press **STOP** key to quit the accumulative running time displaying;

Parameter adjusting procedure of Model No: M931

Note:

- 1)The manufacturer suggests the pump user to adjust this setting value after Parameter Calibrating completed!
- 2)The manufacturer does not recommend the pump users to adjust in case of some operation, if the users have specially technical requirement say: current of no load (dry run) etc, supplier can set before exit factory!
- 3)Following value data is theoretic, in real time operation, calculation error allowed!
- 4)Confidential document, do not disclose!

Step 1: (suppose controller is applied for water supply by liquid level control and rated ampere is 5A)

press  button to switch to manual state, LCD displays:

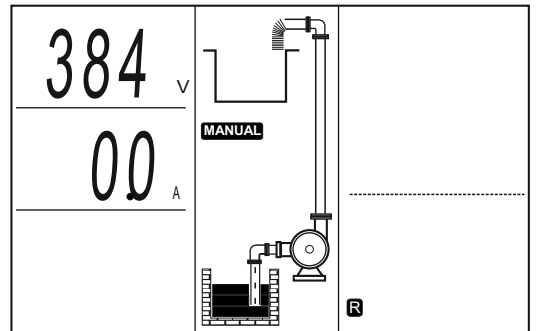



make sure the pump not running;

Step 2:

hold pressing  button for at least 5seconds, till controller makes a buzzer sound and

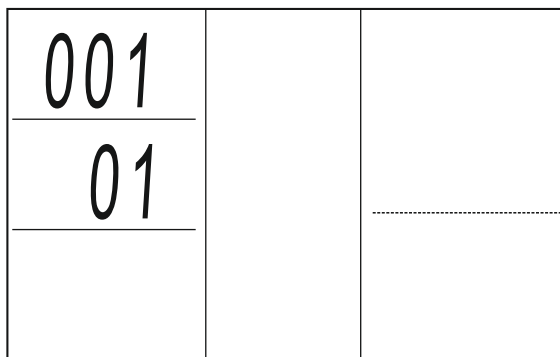
LCD displays:





loosen  button and enter into parameter adjusting manual;

Step 3:

after entering into parameter manual, press  button to select the parameter code;

Step 4:

press  button to add or press  button to decrease the parameter setting value according to the user's specific technical requirement;

Step 5:

after adjusting completed, hold pressing  button for at least 5seconds, till controller

makes a buzzer sound and LCD displays:

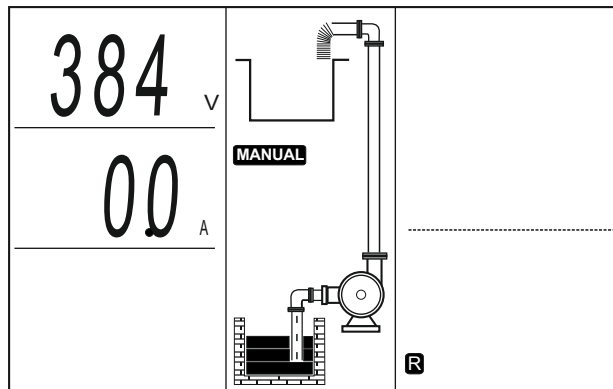

loosen  button, adjusting store completed.

adjusting store completed.

Parameter manual and code meaning:

LCD displays	Meaning									
<table border="1" style="width: 100%; height: 100%;"> <tr> <td style="width: 30%; text-align: center; vertical-align: top;">001</td> <td style="width: 30%;"></td> <td style="width: 40%;"></td> </tr> <tr> <td style="text-align: center; vertical-align: top;">01</td> <td></td> <td style="border-top: 1px dashed black;"></td> </tr> <tr> <td></td> <td></td> <td></td> </tr> </table>	001			01						<p>The controller ID</p>
001										
01										
<table border="1" style="width: 100%; height: 100%;"> <tr> <td style="width: 30%; text-align: center; vertical-align: top;">002</td> <td style="width: 30%;"></td> <td style="width: 40%;"></td> </tr> <tr> <td style="text-align: center; vertical-align: top;">04</td> <td></td> <td style="border-top: 1px dashed black;"></td> </tr> <tr> <td></td> <td></td> <td></td> </tr> </table>	002			04						<p>RS 485 Speed, 01 on behalf of 1200,02 on behalf of 2400 , 03 on behalf of 4800,04 on behalf of 9600</p>
002										
04										
<table border="1" style="width: 100%; height: 100%;"> <tr> <td style="width: 30%; text-align: center; vertical-align: top;">003</td> <td style="width: 30%;"></td> <td style="width: 40%; text-align: right; vertical-align: top;">DRY RUN</td> </tr> <tr> <td style="text-align: center; vertical-align: top;">06^s</td> <td></td> <td style="border-top: 1px dashed black;"></td> </tr> <tr> <td></td> <td></td> <td></td> </tr> </table>	003		DRY RUN	06 ^s						<p>Rdry run protection trip response time , unit is second(s) Default setting value is 6 seconds</p>
003		DRY RUN								
06 ^s										
<table border="1" style="width: 100%; height: 100%;"> <tr> <td style="width: 30%; text-align: center; vertical-align: top;">004</td> <td style="width: 30%;"></td> <td style="width: 40%; text-align: right; vertical-align: top;">DRY RUN</td> </tr> <tr> <td style="text-align: center; vertical-align: top;">030^M</td> <td></td> <td style="border-top: 1px dashed black;"></td> </tr> <tr> <td></td> <td></td> <td></td> </tr> </table>	004		DRY RUN	030 ^M						<p>Recovery time for dry run protection ,unit is minute(M) Default setting value is 30 minutes</p>
004		DRY RUN								
030 ^M										

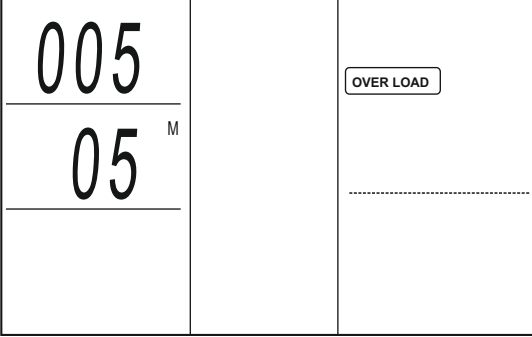
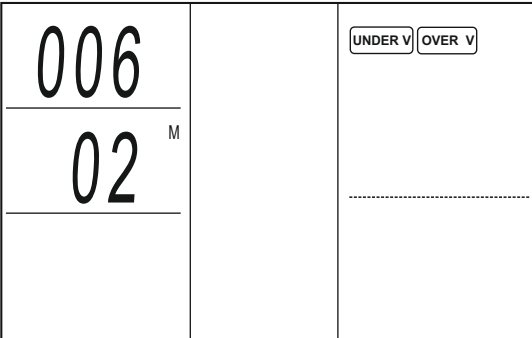
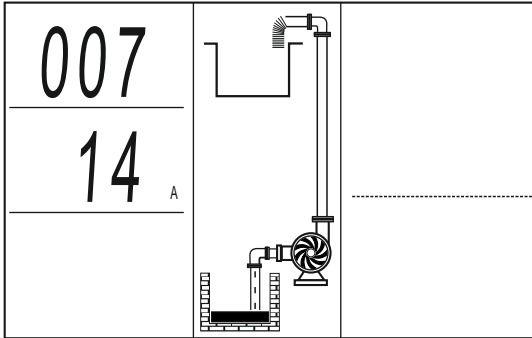
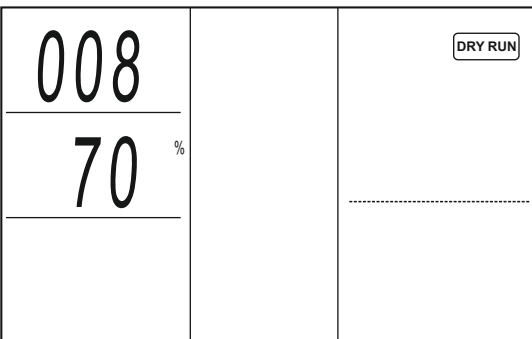
LCD displays	Meaning
 <p>The LCD display shows the parameter code '005' in the top line and the value '05' with a unit 'M' in the second line. A small rectangular box labeled 'OVER LOAD' is positioned in the upper right area of the display.</p>	<p>Trip ampere of over load protection ,unit is ampere,when running ampere is higher this value ,controller will be in over load protection state within 5 minutes</p>
 <p>The LCD display shows the parameter code '006' in the top line and the value '02' with a unit 'M' in the second line. Two small rectangular boxes labeled 'UNDER V' and 'OVER V' are positioned in the upper right area of the display.</p>	<p>Trip ampere of under / over voltage protection , unit is voltage (V),when running voltage is below or higher this value ,controller will be in under/ over voltage protection state within 2 minutes</p>
 <p>The LCD display shows the parameter code '007' in the top line and the value '14' with a unit 'A' in the second line. To the right of the display is a schematic diagram of a pump system, including a pump unit, a vertical pipe, and a tank.</p>	<p>The rated output power of pump is 14A Default setting is 14A</p>
 <p>The LCD display shows the parameter code '008' in the top line and the value '70' with a unit '%' in the second line. A small rectangular box labeled 'DRY RUN' is positioned in the upper right area of the display.</p>	<p>The trip response ratio of dry running protection is 70% of rated current . Default setting is 70%</p>

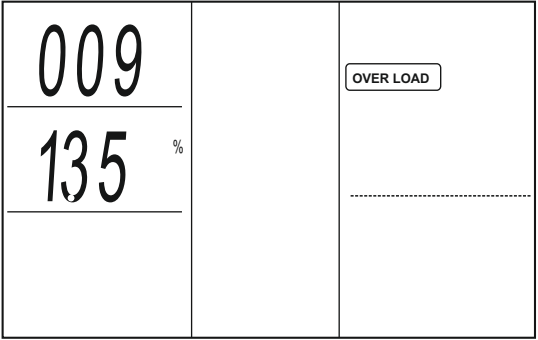
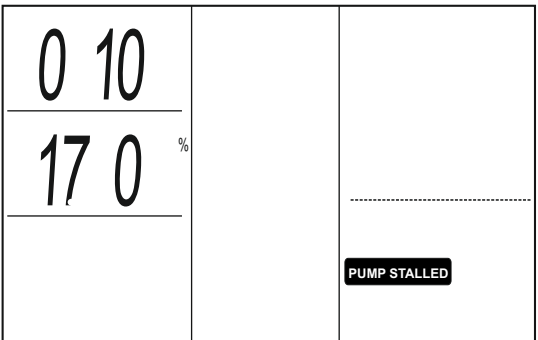
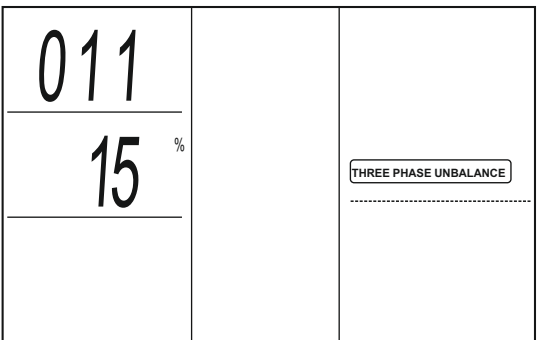
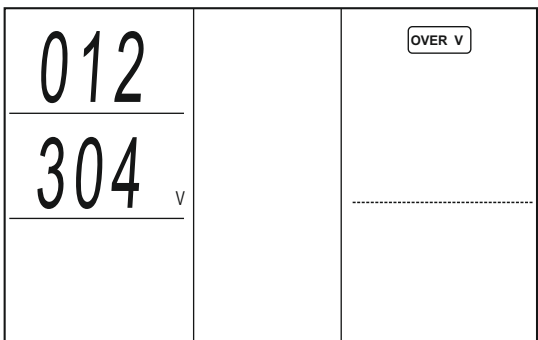
LCD displays	Meaning
 <p>The LCD display shows the code '009' in the top left, '135' with a '%' symbol in the middle left, and a small box labeled 'OVER LOAD' in the top right. A horizontal dashed line is present in the bottom right area.</p>	<p>The trip response ratio of over load protection is 135% of rated current Default setting is 135%</p>
 <p>The LCD display shows the code '010' in the top left, '170' with a '%' symbol in the middle left, and a small box labeled 'PUMP STALLED' in the bottom right. A horizontal dashed line is present in the middle right area.</p>	<p>The trip response ratio of pump stalled protection is 170% of rated current Default setting is 170%</p>
 <p>The LCD display shows the code '011' in the top left, '15' with a '%' symbol in the middle left, and a small box labeled 'THREE PHASE UNBALANCE' in the middle right. A horizontal dashed line is present in the bottom right area.</p>	<p>The trip response ratio of pump phase unbalance protection is $\pm 15\%$ of rated voltage ,if the working voltage below or above 15% of the rated voltage ,then controller will order pump stop running</p>
 <p>The LCD display shows the code '012' in the top left, '304' with a 'V' symbol in the middle left, and a small box labeled 'OVER V' in the top right. A horizontal dashed line is present in the bottom right area.</p>	<p>Trip voltage of Under voltage protection, unit is voltage (V),when running voltage is below this value, controller will be in under voltage protection state Default setting value is 304V</p>

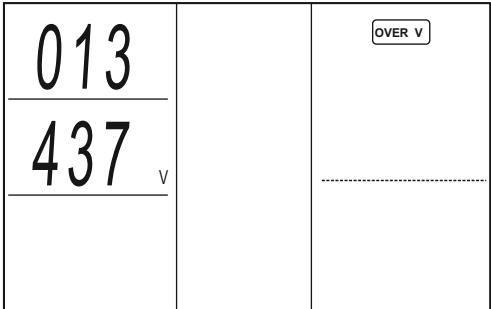
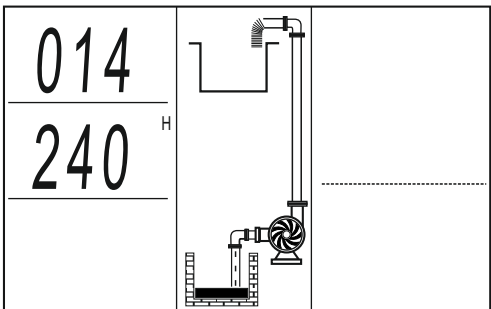
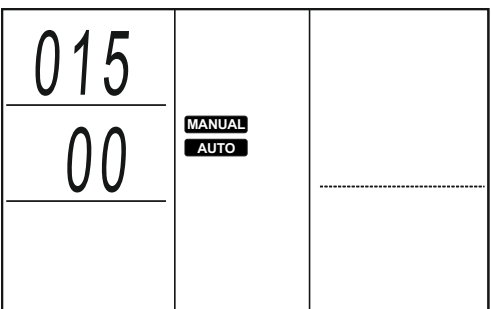
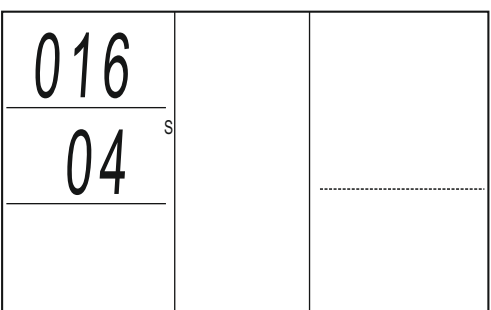
LCD displays	Meaning
	<p>Trip voltage of Over voltage protection , unit is voltage (V),when running voltage is over this value, controller will be in over voltage protection state Default setting value is 437V</p>
	<p>Note :Only Applicable for Drainage application Under auto state, if controller inspects pumps not running for 240 hours, controller will order pumps to run for 3seconds. Auto patrol can prevent pump rusty and impeller jammed owing to long time no operation. Default setting is 240 hours</p>
	<p>LCD screen locked function under auto state , the default setting value is 000 which stands for the controller LCD screen haven't been locked ,if pump users request for LCD screen locked function ,they have to change the value to "111" by The parameter can't be changed if the controller with LCD screen locked function</p>
	<p>Cut off time delay function ,this function only apply for pressure booster pumping system by adopting pressure transmitter (0. 5-4. 5V) Default setting value is 4 seconds</p>

Note :

- 1.Pump users can set the function switch to meet different application requirement and the parameter menu will be different for each applications :
2. the parameter setting value need to be reset if the controller used for different application

Option one : Apply for water supply by pressure transmitter ,the function switch position is as follows :

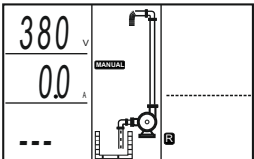
		<p>Applied for water supply by pressure transmitter</p>
-----------------------------------------------------------------------------------	-----------------------------------------------------------------------------------	---------------------------------------------------------

Parameter menu from item 001-016 are the same ,the difference are as follows :

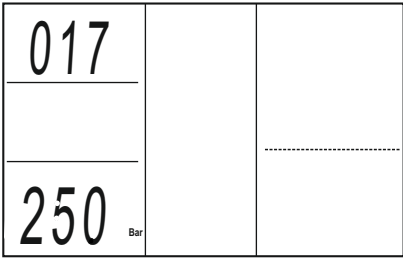
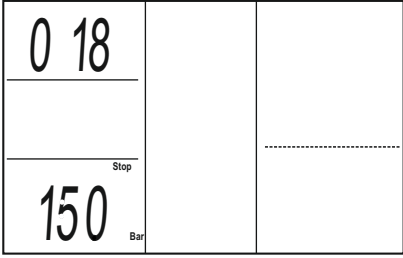
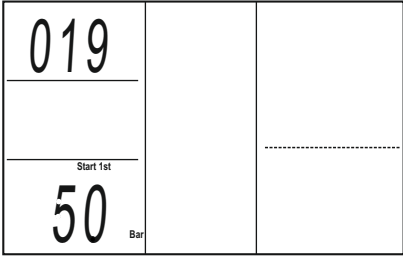
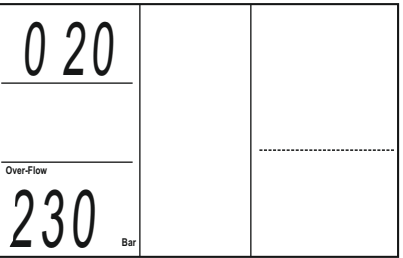
LCD displays	Meaning
	<p>The largest measure range for the pressure transmitter is 25 Bar</p>
	<p>Pressue value for pump cut off setting Note : pump users can reset the value according to their actually request</p>
	<p>Pressue value for pump cut in setting Note : pump users can reset the value according to their actually request</p>
	<p>Pressure value for Alarm</p>

Option Two : Apply for drainage by level transmitter , the function switch position is as follows

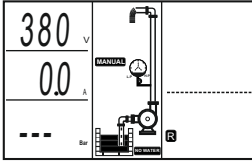
		<p>Applied for drainage by level transmitter</p>
-----------------------------------------------------------------------------------	-----------------------------------------------------------------------------------	--------------------------------------------------

Parameter menu from item 001-016 are the same ,the difference are as follows :

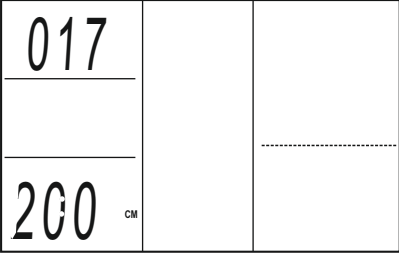
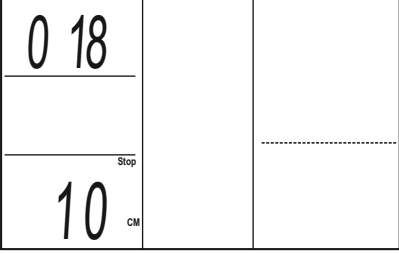
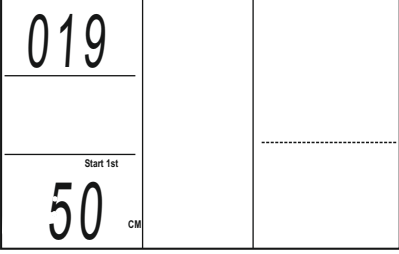
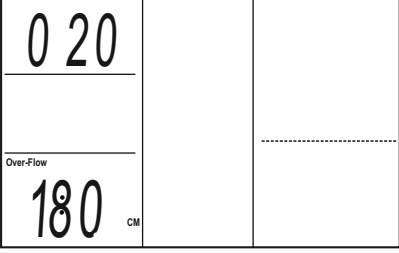
LCD displays	Meaning
	<p>The largest measure range for the level transmitter is 200cm</p>
	<p>Depth value for pump cut off setting Note: pump users can reset the value according to their actually request</p>
	<p>Depth value for pump cut in setting Note:pump users can reset the value according to their actually request</p>
	<p>The depth value for overflow</p>

Option Three : Apply for water supply by level transmitter , the function switch position is as follows

		<p>Applied for water supply by level transmitter</p>
--	--	------------------------------------------------------

Parameter menu from item 001-016 are the same ,the different are as follows

LCD displays	Meaning
	<p>The largest measure range for the level transmitter is 200cm</p>
	<p>Depth value for pump cut off setting Note: pump users can reset the value according to their actually request</p>
	<p>Depth value for pump cut in setting Note:pump users can reset the value according to their actually request</p>
	<p>The depth value for overflow</p>

5 TROUBLE SHOOTING GUIDE

Fault Message	Possible Cause	Solutions
flashing of UNDER V	the real running voltage is lower than the calibrated voltage, pump is in under voltage protection state	report low line voltage to the power supply company
		M931 will attempt to restart the pump every 5minutes until line voltage is restored to normal
flashing of OVER V	the real running voltage is higher than the calibrated voltage, pump is in over voltage protection state	report high line voltage to the power supply company
		M931 will attempt to restart the pump every 5minutes until line voltage is restored to normal
flashing of OVER LOAD	the real running ampere is higher than the calibrated running ampere, pump is in over load protection state	M931 will attempt to restart the pump every 30minutes until running ampere is restored to normal
	pump impeller is jammed / pump motor dragging / pump bearing broken	check pump impeller or bearing
flashing of OPEN PHASE	power supply lose phase	report to the power supply company
	controller inlet wire or pumpcable broken	repair inlet wire or pump cable
flashing of PUMP NO CALIBRATION	parameter calibration not completed	refer to parameter calibration setting
flashing of DRY RUN	liquid level in the well / sump is below the pump intake, pump stops running	M931 will attempt to restart the pump every 30minutes until liquid level above the pump intake

Fault Message	Possible Cause	Solutions
flashing of PUMP STALLED	pump motor running ampere increasing was greater than the normal running ampere (calibrated ampere) by more than 200%	cut off power supply & repair or replace pump immediately
flashing of THREE PHASE UNBALANCE	the real voltage (ampere) between three phase (R/S/T) is not same and the difference is more than $\pm 15\%$	report to the power supply company M931 will attempt to restart the pump every 5 minutes until the voltage (ampere) between three phases is restored to normal
flashing of PHASE REVERSAL	sequence of the three phase input voltage (R/S/T) error	change the sequence of the three phase (R/S/T)
flashing of REPEATED START	pump starts more than 5 times per minutes	The most common cause for the rapid cycle condition is a waterlogged tank. Check for a ruptured bladder in the water tank. Check the air volume control or sniffer valve for proper operation Check the setting on the pressure switch and examine for defects Cut off the power supply & repair the water tank, pressure switch or valve
flashing of OVER TEMP	The temperature in pump motor winding is high and the contacting point of the thermal switch is in open circuit state	Waiting the temperature in pump motor winding cooling down, the contacting point of the thermal switch is close circuit state
	no communication link between SC / computer and M931	connecting the M931 to SC / computer to realize long distance monitoring